

EMC Test Report

Report No.: STS2403128E06

Issued for

Suparo Industries Ltd

Weir Street Blackburn BB2 2AN United Kingdom

Product Name: Suparo Type C to Type C cable-PD100W

Brand Name: Suparo

Model Name: S1001B

Series Model(s): S1001W, S1002W, S1002B

Test Standards: BS EN 55032:2015/A11:2020
BS EN IEC 61000-3-2:2019/A1:2021
BS EN 61000-3-3:2013/A2:2021
BS EN 55035:2017/A11:2020

The test results presented in this report relate only to the object tested. This report shall not be reproduced, except in full, without the written approval of the Shenzhen STS Test Services Co., Ltd.



TEST REPORT

Applicant's Name.....: Suparo Industries Ltd

Address.....: Weir Street Blackburn BB2 2AN United Kingdom

Manufacturer's Name.....: Microwoo Electronic Technology Co.,Ltd

Address.....: NO.13, Hengrui 2nd Road, Tangxiayong Community, Yan Luo Street, Baoan District, Shenzhen

Product Description

Product Name.....: Suparo Type C to Type C cable-PD100W

Brand Name.....: Suparo

Model Name: S1001B

Series Model(s): S1001W, S1002W, S1002B

Test Standards: BS EN 55032:2015/A11:2020
BS EN IEC 61000-3-2:2019/A1:2021
BS EN 61000-3-3:2013/A2:2021
BS EN 55035:2017/A11:2020

The test results presented in this report relate only to the object tested. This report shall not be reproduced, except in full, without the written approval of the Shenzhen STS Test Services Co., Ltd.

Date of Test..... :

Date of Receipt of Test Item..... : 22 Mar. 2024

Date (s) of Performance of Tests : 22 Mar. 2024 ~ 17 Apr. 2024

Date of Issue : 17 Apr. 2024

Test Result : **Pass**

Testing Engineer : Star Deng
(Star Deng)

Technical Manager : Chris Chen
(Chris Chen)

Authorized Signatory : Bovey Yang
(Bovey Yang)





TABLE OF CONTENTS

1. TEST SUMMARY	5
1.1 TEST FACTORY	6
1.2 MEASUREMENT UNCERTAINTY	6
2. GENERAL INFORMATION	7
2.1 GENERAL DESCRIPTION OF THE EUT	7
2.2 DESCRIPTION OF THE TEST MODES	8
2.3 DESCRIPTION OF THE TEST SETUP	9
2.4 MEASUREMENT INSTRUMENTS LIST	10
3. EMC EMISSION TEST	13
3.1 CONDUCTED EMISSION MEASUREMENT	13
3.2 RADIATED EMISSION MEASUREMENT	17
3.3 HARMONICS CURRENT	23
3.4 VOLTAGE FLUCTUATION AND FLICKERS	25
4. EMC IMMUNITY TEST	27
4.1 STANDARD COMPLIANCE/SERVRITY LEVEL/CRITERIA	27
4.2 GENERAL PERFORMANCE CRITERIA	28
4.3 ELECTROSTATIC DISCHARGE IMMUNITY TEST (ESD)	29
4.4 RADIATED, RADIO-FREQUENCY, ELECTROMAGNETIC FIELD IMMUNITY TEST (RS)	33
4.5 ELECTRICAL FAST TRANSIENT (EFT)	36
4.6 SURGE TESTING	40
4.7 CONDUCTED RADIO FREQUENCY DISTURBANCES (CS)	43
4.8 VOLTAGE INTERRUPTION/DIPS TESTING (DIPS)	46
APPENDIX 1 - TEST SETUP	48
APPENDIX 2 - PHOTOGRAPHS OF EUT CONSTRUCTIONAL DETAILS	53



Revision History

Rev.	Issue Date	Report No.	Effect Page	Contents
00	17 Apr. 2024	STS2403128E06	ALL	Initial Issue

1. TEST SUMMARY

Test procedures according to the technical standards:

EMC Emission				
Standard	Test Item	Limit	Judgement	Remark
BS EN 55032:2015/A11:2020	Conducted Emission on AC And Telecom Port 150kHz to 30MHz	Class B	PASS	
	Radiated Emissions	Class B	PASS	NOTE (1)
BS EN IEC 61000-3-2:2019/A1:2021	Harmonic Current Emission	Class A	N/A	NOTE (2)
BS EN 61000-3-3:2013/A2:2021	Voltage Fluctuations & Flicker	-----	PASS	
EMC Immunity				
Section	Test Item	Performance Criteria	Judgement	Remark
BS EN 55035:2017/A11:2020				
BS EN 61000-4-2:2009	Electrostatic discharges	B	PASS	
BS EN IEC 61000-4-3:2020	Continuous RF electromagnetic field disturbances	A	PASS	
BS EN 61000-4-4:2012	Electrical fast transients/burst	B	PASS	
BS EN 61000-4-5:2014/A1:2017	Surges	B	PASS	
BS EN 61000-4-6:2014+AC:2015	Continuous induced RF disturbances	A	PASS	
BS EN 61000-4-8:2010	Power frequency magnetic field	A	N/A	
BS EN IEC 61000-4-11:2020	Voltage dips and interruptions	B / C / C	PASS	NOTE (3)

- Note:**
- (1) If the highest frequency of the internal sources of the EUT is less than 108 MHz, the measurement shall only be made up to 1 GHz.
 If the highest frequency of the internal sources of the EUT is between 108 MHz and 500 MHz, the measurement shall only be made up to 2 GHz.
 If the highest frequency of the internal sources of the EUT is between 500 MHz and 1GHz, the measurement shall only be made up to 5 GHz.
 If the highest frequency of the internal sources of the EUT is above 1 GHz, the measurement shall be made up to 5 times of the highest frequency or 6 GHz, whichever is less.
 - (2) The power consumption of EUT is less than 75W and no Limits apply.
 - (3) Voltage Dip: 100% reduction – Performance Criteria **B**
 Voltage Dip: 30% reduction – Performance Criteria **C**
 Voltage Interruption: 100% Interruption – Performance Criteria **C**
 - (4) N/A=Not Applicable.



1.1 TEST FACTORY

Company Name:	SHENZHEN STS TEST SERVICES CO.,LTD.
Address:	101, Building B, Zhuoke Science Park, No.190 Chongqing Road, ZhanChengShequ, Fuhai Sub-District, Bao'an District, Shenzhen, Guang Dong, China
Telephone:	+86-755 3688 6288
Fax:	+86-755 3688 6277
Registration No.:	FCC test Firm Registration Number: 625569
	IC test Firm Registration Number: 12108A
	A2LA Certificate No.: 4338.01

1.2 MEASUREMENT UNCERTAINTY

The reported uncertainty of measurement $y \pm U$, where expanded uncertainty U is based on a standard uncertainty multiplied by a coverage factor of $k=2$, providing a level of confidence of approximately **95 %**.

A. Conducted Measurement:

Test Site	Method	Measurement Frequency Range	U , (dB)	NOTE
STSC01	CISPR 16-4-2	9KHz ~ 150KHz	2.19	
		150KHz ~ 30MHz	2.53	

B. Radiated Measurement:

Test Site	Method	Measurement Frequency Range	U , (dB)	NOTE
STSC02	CISPR 16-4-2	30MHz ~ 1000MHz	4.18	
		1GHz ~ 6 GHz	4.90	



2. GENERAL INFORMATION

2.1 GENERAL DESCRIPTION OF THE EUT

Product Name	Suparo Type C to Type C cable-PD100W
Brand Name	Suparo
Model Name	S1001B
Series Model(s)	S1001W, S1002W, S1002B
Model Difference	The color and length are different
Product Description	The EUT is a Suparo Type C to Type C cable-PD100W. ITE equipment having a primary function of either (or a combination of) entry, storage, display, retrieval, transmission, processing, switching, or control of data and/or telecommunication messages and which may be equipped with one or more ports typically for information transfer.
Rating	Input: DC 20V/5A Output: 100W-20V/5A
Hardware Version Number	N/A
Software Version Number	N/A

2.2 DESCRIPTION OF THE TEST MODES

To investigate the maximum EMI emission characteristics generated from EUT, the test system was pre-scanning tested based on the consideration of following EUT operation mode or test configuration mode which possibly have effect on EMI emission level. Each of these EUT operation mode(s) or test configuration mode(s) mentioned above was evaluated respectively.

Pretest Mode	Description
Mode 1	Charging
Mode 2	PC+USB Transmitting

For Conducted Test	
Final Test Mode	Description
Mode 1	Charging

For Radiated Test	
Final Test Mode	Description
Mode 1	Charging

For EMS Test	
Final Test Mode	Description
Mode 1	Charging
Mode 2	PC+USB Transmitting

Note:

1. For conducted emission test, test mode 1 was the worst case and only this mode was presented in this report.
2. For radiated emission test, test mode 1 was the worst case and only this mode was presented in this report.
3. The device has been tested with normal voltage (For 110V, 50/60Hz and 230V, 50/60Hz). The report only shows the worst result which is tested with 230V/ 50Hz.

2.3 DESCRIPTION OF THE TEST SETUP

The EUT has been tested with associated equipment below and the test setup please refer to appendix 1 - test setup.

Necessary accessories

Item	Equipment	Mfr/Brand	Model/Type No.	Length	Note
	N/A	N/A	N/A	N/A	N/A

Support units

Item	Equipment	Mfr/Brand	Model/Type No.	Length	Note
	Adapter	SZTY	TPA-46050100VU	N/A	N/A
	Personal computer	DELL	Inspiron 14-3467	N/A	N/A
	Mobile Phone	UNNECTO	k39tv1_64_bsp	N/A	N/A

Note:

- (1) For detachable type I/O cable should be specified the length in cm in 『Length』 column.
- (2) “YES” means “with core”; “NO” means “without core”.

2.4 MEASUREMENT INSTRUMENTS LIST

2.4.1 CONDUCTED TEST SITE

Kind of Equipment	Manufacturer	Type No.	Serial No.	Last Calibration	Calibrated Until
EMI Test Receiver	R&S	ESCI	101427	2023.9.25	2024.9.24
LISN	R&S	AiT-F01220	8130179	2023.9.25	2024.9.24
Absorbing Clamp	R&S	MDS-21	100668	2024.2.23	2025.2.22
CE Cable	N/A	C01	N/A	2023.9.25	2024.9.24
EMF Antenna	SCHWARZBECK	VDHH 9502	147	2023.9.25	2024.9.24
Temperature & Humidity	Mieo	HH660	N/A	2023.9.28	2024.9.27
Testing Software	EZ-EMC(Ver.STSLAB-03A1 CE)				

2.4.2 RADIATED TEST SITE

Kind of Equipment	Manufacturer	Type No.	Serial No.	Last Calibration	Calibrated Until
EMI Test Receiver	R&S	ESCI	101427	2023.9.25	2024.9.24
Bi-log Antenna	TESEQ	CBL6111D	45873	2023.9.27	2024.9.26
Horn Antenna	SCHWARZBECK	BBHA 9120D	9120D-1343	2023.9.27	2024.9.26
Pre-amplifier(1G-26.5G)	Agilent	HP8449B	3008A02383	2024.2.23	2025.2.22
Pre-amplifier(0.1M-3GHz)	EM	EM330	060665	2024.2.23	2025.2.22
Spectrum Analyzer	Agilent	N9020A	MY49100060	2023.9.26	2024.9.25
RE Cable (9K-1G)	N/A	R01	N/A	2023.9.25	2024.9.24
RE Cable (1G-26G)	N/A	R02	N/A	2023.9.25	2024.9.24
Temperature & Humidity	Mieo	HH660	N/A	2023.9.28	2024.9.27
Testing Software	EZ-EMC(Ver.STSLAB-03A1 RE)				

2.4.3 HARMONICS AND FLICKER

Kind of Equipment	Manufacturer	Type No.	Serial No.	Last Calibration	Calibrated Until
Harmonic Voltage & Flicker	LAPLACE	AC 2000A	311217	2023.9.25	2024.9.24
AC Power Source	MTONI	PHF-5010	631169	2023.9.25	2024.9.24
Temperature & Humidity	Mieo	HH660	N/A	2023.9.28	2024.9.27
Testing Software	HA-PC Link Version 3.03				



2.4.4 ESD

Kind of Equipment	Manufacturer	Type No.	Serial No.	Last Calibration	Calibrated Until
ESD TEST GENERATOR	TESEQ	NSG438	1175	2023.9.27	2024.9.26
Temperature & Humidity	N/A	WS1066	N/A	2024.2.23	2025.2.22

2.4.5 SURGE, EFT/BURST, VOLTAGE INTERRUPTION/DIPS

Kind of Equipment	Manufacturer	Type No.	Serial No.	Last Calibration	Calibrated Until
Surger Generator	HTEC	HCWG 100	225202	2024.2.23	2025.2.22
Surger Generator	HTEC	HTW	152104	2023.9.25	2024.9.24
VOLTAGE DIPS & INTERRUPTIONS Generator	HTEC	HPFS 161P	143803	2024.2.23	2025.2.22
EFT/B Generator	HTEC	HEFT 51	1920001	2023.9.25	2024.9.24
Temperature & Humidity	Mieo	HH660	N/A	2023.9.28	2024.9.27

2.4.6 RS

Kind of Equipment	Manufacturer	Type No.	Serial No.	Last Calibration	Calibrated Until
Power Meter	Agilent	E4419B	QB43312265	2023.9.25	2024.9.24
Power Sensor	hp	E9300A	US39210170	2023.9.25	2024.9.24
Power Sensor	hp	E9300A	US39210476	2023.9.25	2024.9.24
Signal Generator	Agilent	N5181A	MY56144718	2023.9.25	2024.9.24
Power Amplifier	MICOTOP	MPA-80-1000-250	MPA1711489	2023.9.25	2024.9.24
Power Amplifier	MICOTOP	MPA-1000-6000-100	MPA1904132	2023.9.25	2024.9.24
RS Test Antenna (80-1GHz)	SCHWARZBECK	VULP 9118E	000999	N/A	N/A
RS Test Antenna (1G-10GHz)	SCHWARZBECK	STLP 9149	000648	N/A	N/A
Universal Radio Communication Tester	R&S	CMU200	116337	2024.2.23	2025.2.22
Audio Analyzer	R&S	UPL	100689	2024.2.23	2025.2.22
Audio Breakthrough Shielding Box	SKET	SB_ABT/C35	N/A	N/A	N/A
Ear Simulator	SKET	AE_ABT/C35	N/A	N/A	N/A
Mouth Simulator	SKET	AM_ABT/C35	N/A	N/A	N/A
1KHz Standard Source	SKET	MSC_ABT/C35	N/A	2023.9.28	2024.9.27
Field Probe	Narda	EP601	611WX80261	2024.2.23	2025.2.22



Temperature & Humidity	Mieo	HH660	N/A	2023.9.28	2024.9.27
Testing Software	EMC-S V1.4.0.53				

2.4.7 INJECTION CURRENT

Kind of Equipment	Manufacturer	Type No.	Serial No.	Last Calibration	Calibrated Until
CS	SCHLODER	CDG-6000-25	126A1280/2014	2023.9.25	2024.9.24
CDN	SCHLODER	CDN-M2+3	A2210275/2014	2023.9.25	2024.9.24
EM Clamp	SCHLODER	EMCL-20	132A1283	2023.9.25	2024.9.24
Attenuator	Nemtest	ATT-6DB-100	A100W224	2023.9.25	2024.9.24
Universal Radio Communication Tester	R&S	CMU200	111058	2024.2.23	2025.2.22
Audio Analyzer	R&S	UPL	100689	2024.2.23	2025.2.22
Audio Breakthrough Shielding Box	SKET	SB_ABT/C35	N/A	N/A	N/A
Ear Simulator	SKET	AE_ABT/C35	N/A	N/A	N/A
Mouth Simulator	SKET	AM_ABT/C35	N/A	N/A	N/A
1KHz Standard Source	SKET	MSC_ABT/C35	N/A	2023.9.25	2024.9.24
Temperature & Humidity	Mieo	HH660	N/A	2023.9.28	2024.9.27

2.4.8 PFMF

Kind of Equipment	Manufacturer	Type No.	Serial No.	Last Calibration	Calibrated Until
MF Generator	HTEC	HMFG-COMB	143903	2023.9.25	2024.9.24
Magnetic Field Coil	HTEC	HCOIL 100	143808	2023.9.25	2024.9.24
Temperature & Humidity	Mieo	HH660	N/A	2023.9.28	2024.9.27

3. EMC EMISSION TEST

3.1 CONDUCTED EMISSION MEASUREMENT

3.1.1 REQUIREMENTS FOR CONDUCTED EMISSIONS FROM THE AC MAINS POWER PORTS OF THE CLASS A EQUIPMENT

FREQUENCY (MHz)	Coupling device	Detector type / bandwidth	Class A limits dB(μV)
0.15 ~ 0.5	AMN	Quasi Peak / 9 kHz	79
0.5 ~ 30			73
0.15 ~ 0.5	AMN	Average / 9 kHz	66
0.5 ~ 30			60

3.1.2 REQUIREMENTS FOR CONDUCTED EMISSIONS FROM THE AC MAINS POWER PORTS OF THE CLASS B EQUIPMENT

FREQUENCY (MHz)	Coupling device	Detector type / bandwidth	Class B limits dB(μV)
0.15 ~ 0.5	AMN	Quasi Peak / 9 kHz	66 - 56*
0.5 ~ 5			56
5 ~ 30			60
0.15 ~ 0.5	AMN	Average / 9 kHz	56 - 46*
0.5 ~ 5			46
5 ~ 30			50

Note:

- (1) The tighter limit applies at the band edges.
- (2) The limit of " * " marked band means the limitation decreases linearly with the logarithm of the frequency in the range.

The following table is the setting of the receiver

Receiver Parameters	Setting
Attenuation	10 dB
Start Frequency	0.15 MHz
Stop Frequency	30 MHz
IF Bandwidth	9 kHz

3.1.3 TEST PROCEDURE

- a. The EUT was placed 0.4 meters from the conducting wall of the shielded room with EUT being connected to the power mains through a line impedance stabilization network (LISN). Other support units were connected to the power mains through another LISN. The two LISNs provide 50 Ohm/ 50uH of coupling impedance for the measuring instrument.
- b. Interconnecting cables that hang closer than 40 cm to the ground plane shall be folded back and forth in the center forming a bundle 30 to 40 cm long.
- c. I/O cables that are not connected to a peripheral shall be bundled in the center. The end of the cable may be terminated, if required, using the correct terminating impedance. The overall length shall not exceed 1 m.
- d. For the actual test configuration, please refer to the related Item –EUT Test Photos.

3.1.4 TEST SETUP

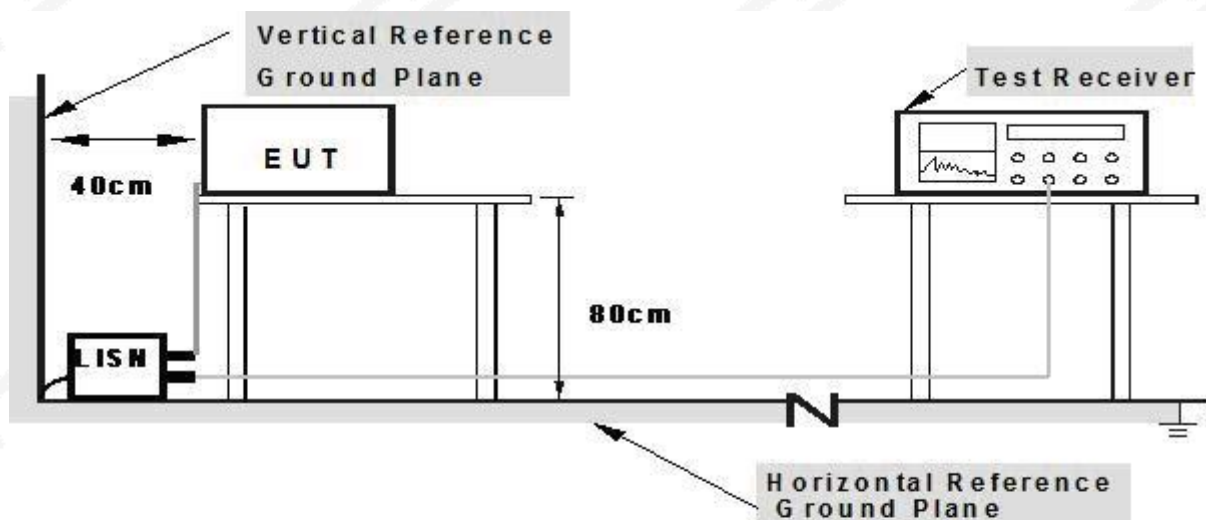

Note: 1. Support units were connected to second LISN.

2. Both of LISNs (AMN) are 80 cm from EUT and at least 80 cm from other units and other metal planes

3.1.5 EUT OPERATING CONDITIONS

The EUT tested system was configured as the statements of 2.3 described unless otherwise a special operating condition is specified in the following during the testing.

3.1.6 TEST RESULTS

Temperature:	24.8°C	Relative Humidity:	56%
Phase:	L	Test Mode:	Mode 1
Test Voltage:	AC 230V/50Hz	Test Date:	2024.03.27

No.	Frequency (MHz)	Reading (dBuV)	Correct Factor (dB)	Result (dBuV)	Limit (dBuV)	Margin (dB)	Detector
1	0.1580	20.73	19.75	40.48	65.57	-25.09	QP
2	0.1580	12.73	19.75	32.48	55.57	-23.09	AVG
3	0.3100	20.04	20.23	40.27	59.97	-19.70	QP
4	0.3100	12.16	20.23	32.39	49.97	-17.58	AVG
5	0.4620	20.32	19.98	40.30	56.66	-16.36	QP
6	0.4620	10.28	19.98	30.26	46.66	-16.40	AVG
7	0.8020	20.36	19.81	40.17	56.00	-15.83	QP
8	0.8020	9.33	19.81	29.14	46.00	-16.86	AVG
9	1.3020	21.04	19.78	40.82	56.00	-15.18	QP
10	1.3020	9.09	19.78	28.87	46.00	-17.13	AVG
11	7.0580	25.76	19.88	45.64	60.00	-14.36	QP
12	7.0580	15.31	19.88	35.19	50.00	-14.81	AVG

Remark:

1. All readings are Quasi-Peak and Average values
2. Margin = Result (Result = Reading + Factor)–Limit
3. Factor = Insertion loss + Cable loss

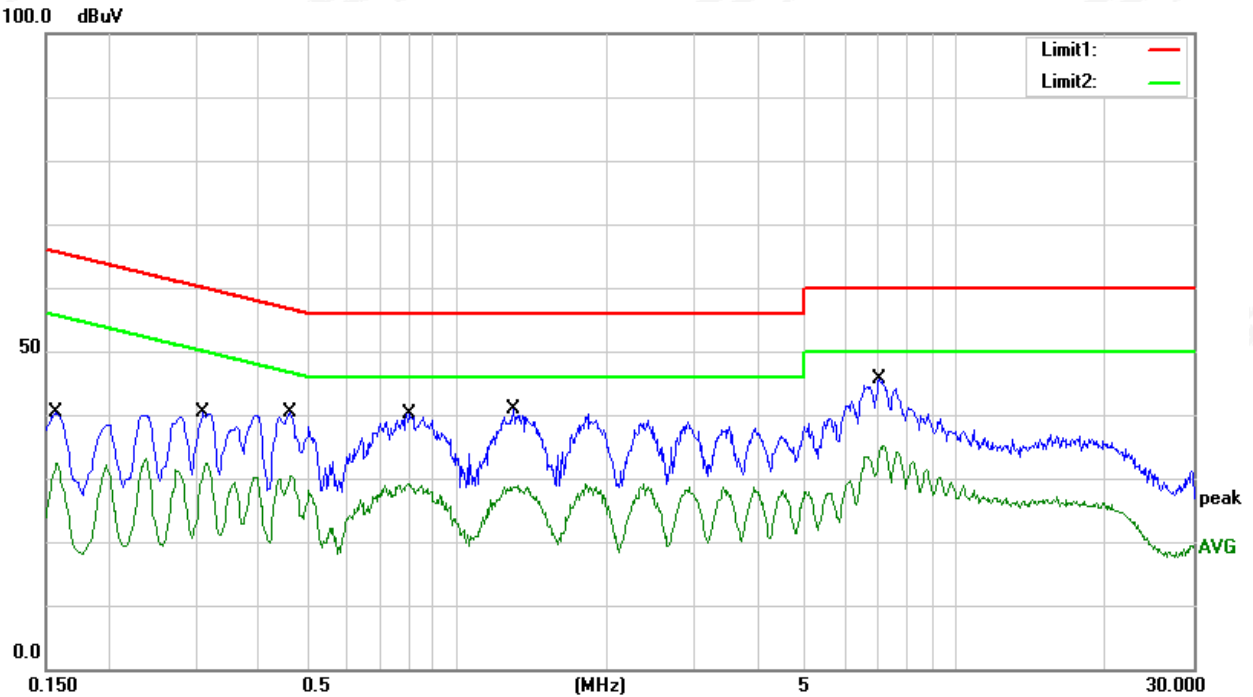



Temperature:	24.8°C	Relative Humidity:	56%
Phase:	N	Test Mode:	Mode 1
Test Voltage:	AC 230V/50Hz	Test Date:	2024.03.27

No.	Frequency (MHz)	Reading (dBUV)	Correct Factor (dB)	Result (dBUV)	Limit (dBUV)	Margin (dB)	Detector
1	0.1500	22.65	19.73	42.38	66.00	-23.62	QP
2	0.1500	7.53	19.73	27.26	56.00	-28.74	AVG
3	0.1700	21.44	19.78	41.22	64.96	-23.74	QP
4	0.1700	2.71	19.78	22.49	54.96	-32.47	AVG
5	0.4620	18.92	19.98	38.90	56.66	-17.76	QP
6	0.4620	4.79	19.98	24.77	46.66	-21.89	AVG
7	4.2020	19.46	19.91	39.37	56.00	-16.63	QP
8	4.2020	4.40	19.91	24.31	46.00	-21.69	AVG
9	4.7060	19.51	19.91	39.42	56.00	-16.58	QP
10	4.7060	4.60	19.91	24.51	46.00	-21.49	AVG
11	7.1100	24.57	19.88	44.45	60.00	-15.55	QP
12	7.1100	9.86	19.88	29.74	50.00	-20.26	AVG

Remark:

- 1. All readings are Quasi-Peak and Average values
- 2. Margin = Result (Result = Reading + Factor)–Limit
- 3. Factor = Insertion loss + Cable loss

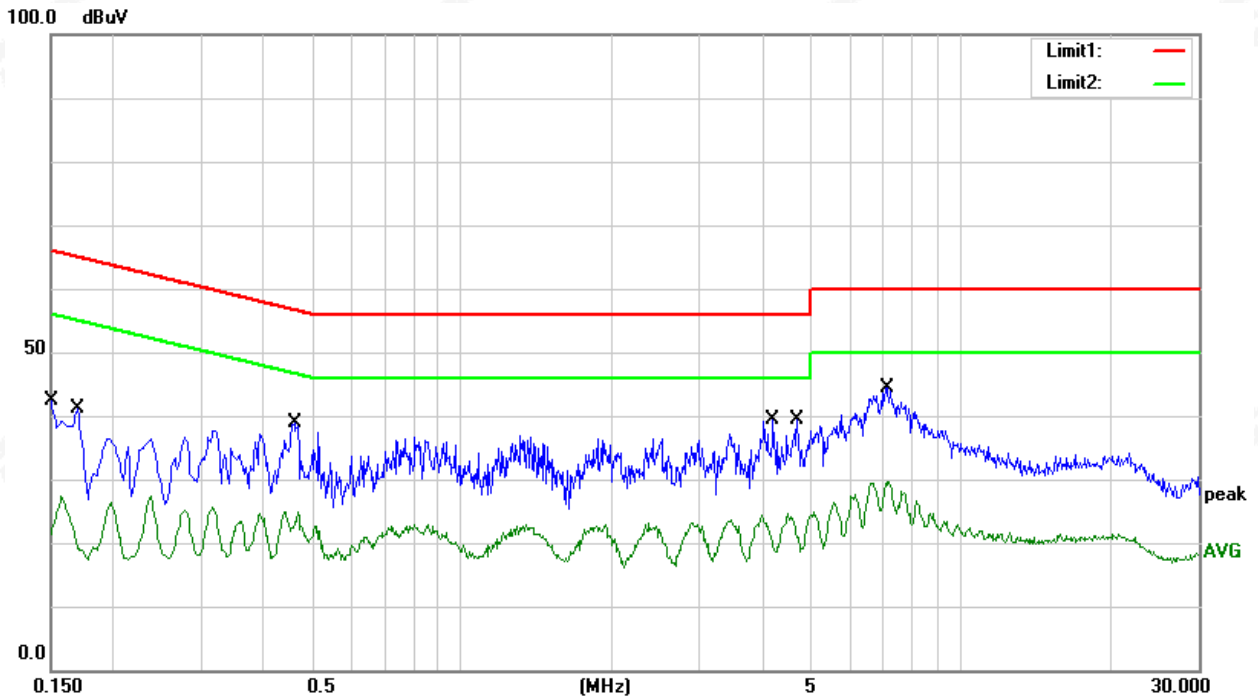

3.2 RADIATED EMISSION MEASUREMENT

3.2.1 LIMITS OF THE RADIATED EMISSION MEASUREMENT

FREQUENCY (MHz)	Distance (m)	Detector type/ bandwidth	Class A	Class B
			dBuV/m	dBuV/m
30 ~ 230	3	Quasi peak/ 120 kHz	50	40
230 ~ 1000	3	Quasi peak/ 120 kHz	57	47
1000 ~ 3000	3	Peak /1 MHz	76	70
3000 ~ 6000	3	Peak /1 MHz	80	74
1000 ~ 3000	3	AV/1 MHz	56	50
3000 ~ 6000	3	AV/1 MHz	60	54

Notes:

- (1) The tighter limit applies at the band edges.
- (2) Emission level (dBuV/m) = 20log Emission level (uV/m).

3.2.3 TEST PROCEDURE

- a. The EUT was placed on the top of a rotating table 0.8 meter above the ground at a 3 meter semi-anechoic chamber room. The table was rotated 360 degrees to determine the position of the highest radiation.
- b. EUT as the center to the edge of the auxiliary device, the distance from the maximum edge to the center of the antenna is 3 meter.
- c. The height of antenna is varied from 1 meter to 4 meter above the ground to determine the maximum value of the field strength. Both horizontal and vertical polarizations of the antenna are set to make the measurement.
- d. For each suspected emission, the EUT was arranged to its worst case and then the antenna was tuned to heights from 1 meter to 4 meter and the rotatable table was turned from 0 degrees to 360 degree to find the maximum reading.
- e. The test-receiver system was set to quasi-peak detect function and specified bandwidth with maximum hold mode when the test frequency is below 1GHz.
- f. For the actual test configuration, please refer to the related Item –EUT Test Photos.

3.2.4 TEST SETUP

(A) Radiated Emission Test Set-Up Frequency Below 1 GHz

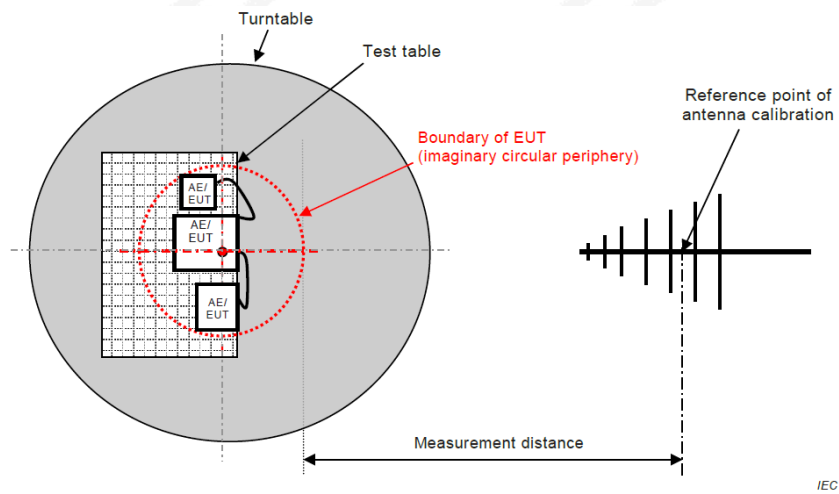

Figure C.1 – Measurement distance

(B) Radiated Emission Test Set-Up Frequency Above 1GHz

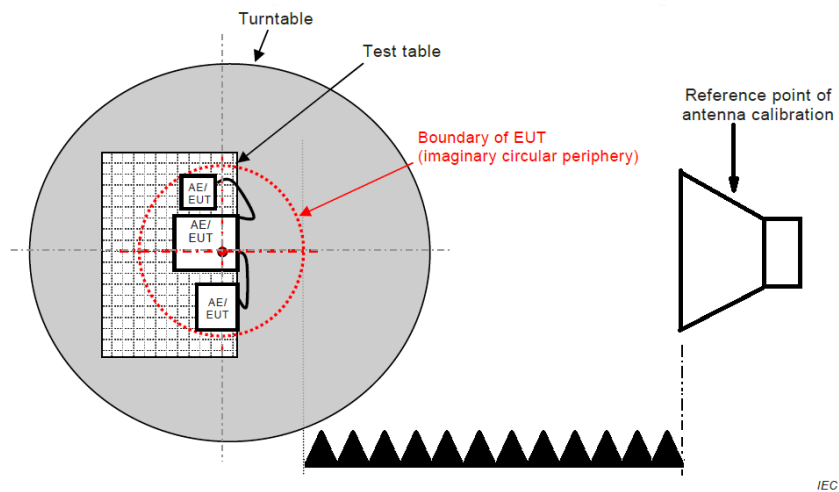

Figure C.1 – Measurement distance

3.2.5 EUT OPERATING CONDITIONS

The EUT tested system was configured as the statements of 2.3 described unless otherwise a special operating condition is specified in the following during the testing.



3.2.6 TEST RESULTS

Temperature:	25.3°C	Relative Humidity:	43%
Phase:	Horizontal	Test Mode:	Mode 1
Test Voltage:	DC 5V	Test Date:	2024.04.16
Describe:	S1001B		

No.	Frequency (MHz)	Reading (dBuV)	Correct Factor (dB)	Results (dBuV/m)	Limit (dBuV/m)	Margin (dB)	Detector
1	60.4920	51.30	-25.90	25.40	40.00	-14.60	QP
2	171.3925	57.67	-20.01	37.66	40.00	-2.34	QP
3	313.2760	60.20	-15.24	44.96	47.00	-2.04	QP
4	377.2590	54.26	-14.57	39.69	47.00	-7.31	QP
5	651.9415	48.04	-8.21	39.83	47.00	-7.17	QP
6	721.7260	45.03	-6.52	38.51	47.00	-8.49	QP

Remark:

- 1. All readings are Quasi-Peak
- 2. Margin = Result (Result = Reading + Factor)–Limit
- 3. Factor= Cable Loss +Antenna Factor–Amplifier Gain

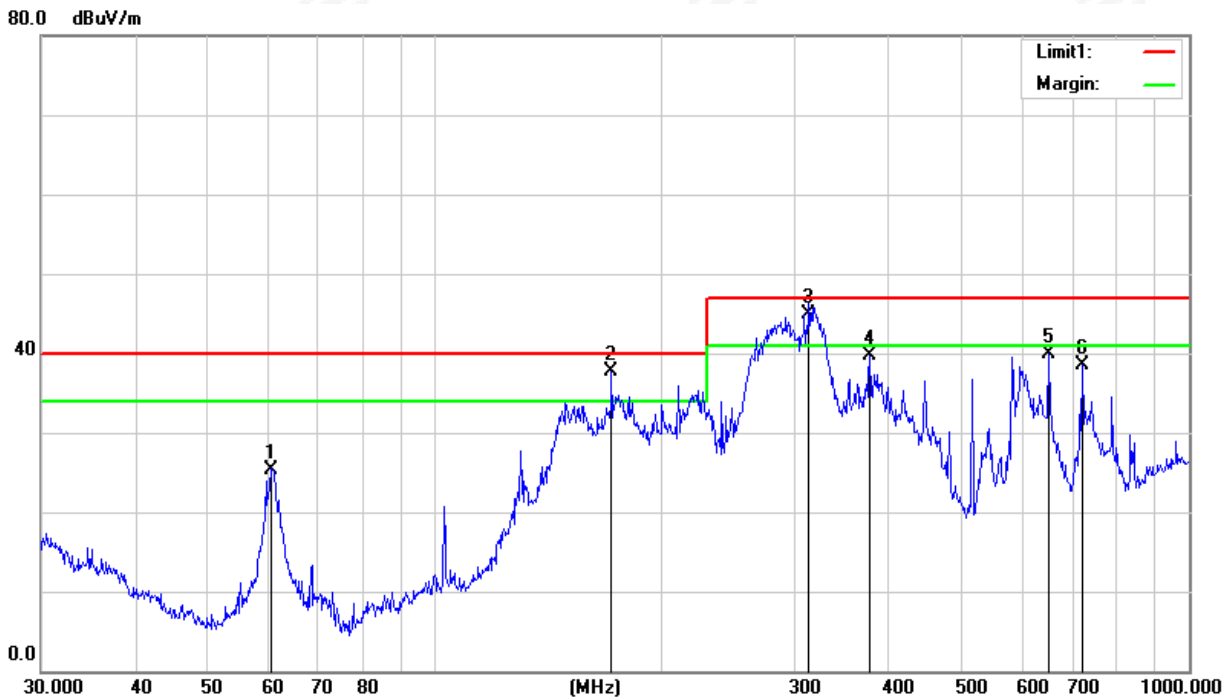



Temperature:	25.3°C	Relative Humidity:	43%
Phase:	Vertical	Test Mode:	Mode 1
Test Voltage:	DC 5V	Test Date:	2024.04.16
Describe:	S1001B		

No.	Frequency (MHz)	Reading (dBuV)	Correct Factor (dB)	Results (dBuV/m)	Limit (dBuV/m)	Margin (dB)	Detector
1	65.5726	48.08	-25.99	22.09	40.00	-17.91	QP
2	165.4866	57.46	-19.32	38.14	40.00	-1.86	QP
3	239.9873	57.87	-19.26	38.61	47.00	-8.39	QP
4	345.5951	52.03	-15.30	36.73	47.00	-10.27	QP
5	616.3718	47.34	-8.74	38.60	47.00	-8.40	QP
6	721.7260	49.36	-6.52	42.84	47.00	-4.16	QP

Remark:

- 1. All readings are Quasi-Peak
- 2. Margin = Result (Result =Reading + Factor)–Limit
- 3. Factor= Cable Loss +Antenna Factor–Amplifier Gain

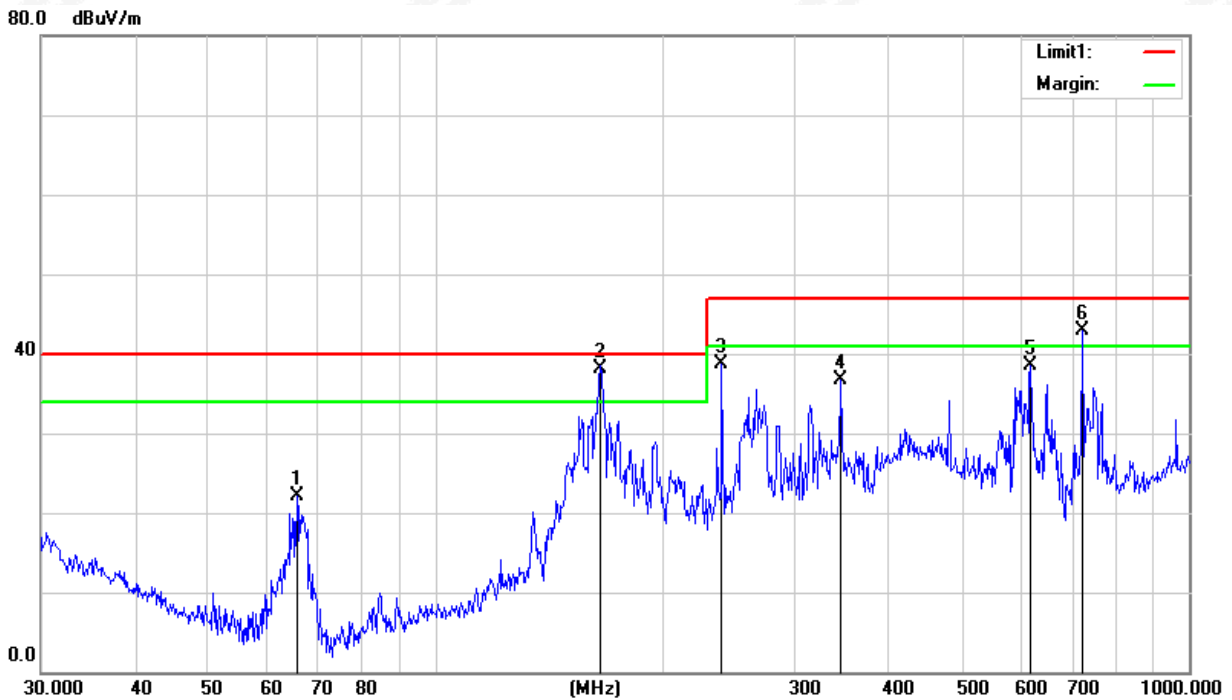



Temperature:	25.3°C	Relative Humidity:	43%
Phase:	Horizontal	Test Mode:	Mode 1
Test Voltage:	DC 5V	Test Date:	2024.03.22
Describe:	S1002B		

No.	Frequency (MHz)	Reading (dBUV)	Correct Factor (dB)	Results (dBUV/m)	Limit (dBUV/m)	Margin (dB)	Detector
1	102.7192	53.78	-19.86	33.92	40.00	-6.08	QP
2	130.8370	56.39	-18.23	38.16	40.00	-1.84	QP
3	284.9766	59.77	-16.25	43.52	47.00	-3.48	QP
4	377.2590	58.02	-14.57	43.45	47.00	-3.55	QP
5	446.4141	53.80	-12.56	41.24	47.00	-5.76	QP
6	925.7563	42.19	-2.63	39.56	47.00	-7.44	QP

Remark:

- 1. All readings are Quasi-Peak
- 2. Margin = Result (Result = Reading + Factor)–Limit
- 3. Factor= Cable Loss +Antenna Factor–Amplifier Gain

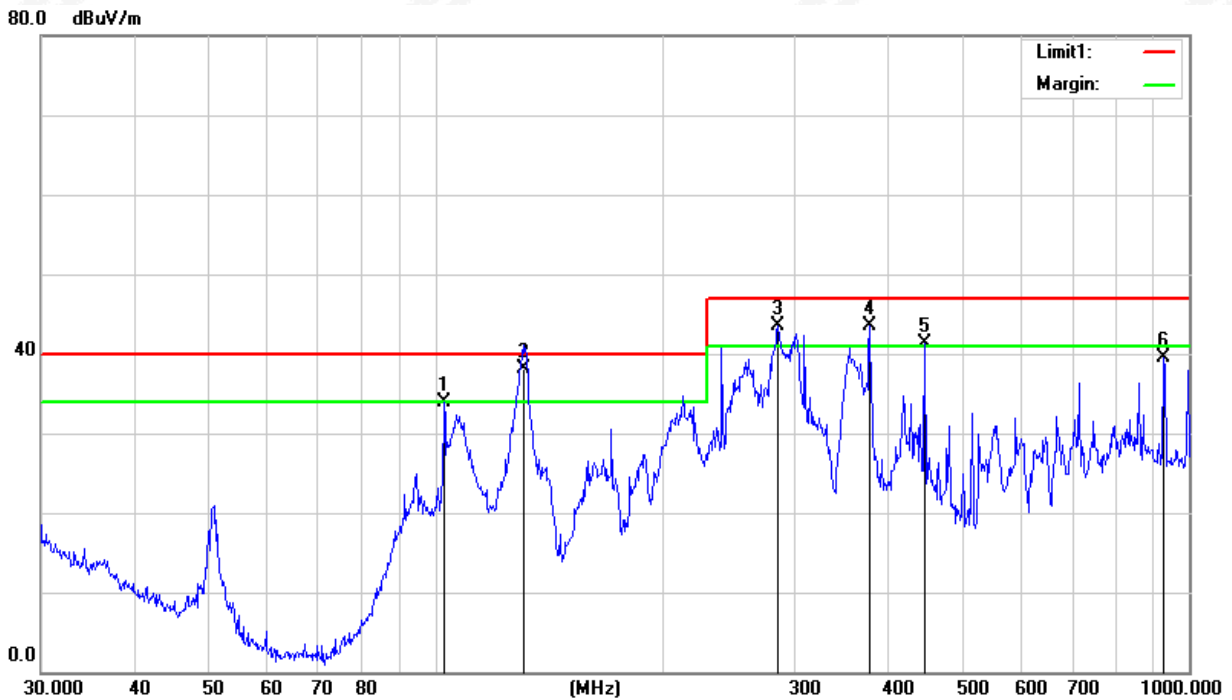



Temperature:	25.3°C	Relative Humidity:	43%
Phase:	Vertical	Test Mode:	Mode 1
Test Voltage:	DC 5V	Test Date:	2024.03.22
Describe:	S1002B		

No.	Frequency (MHz)	Reading (dBuV)	Correct Factor (dB)	Results (dBuV/m)	Limit (dBuV/m)	Margin (dB)	Detector
1	50.4090	43.97	-21.82	22.15	40.00	-17.85	QP
2	130.7590	53.78	-18.22	35.56	40.00	-4.44	QP
3	214.5143	56.28	-20.63	35.65	40.00	-4.35	QP
4	284.9766	50.16	-16.25	33.91	47.00	-13.09	QP
5	480.5276	45.16	-11.00	34.16	47.00	-12.84	QP
6	793.3960	35.22	-4.97	30.25	47.00	-16.75	QP

Remark:

- 1. All readings are Quasi-Peak
- 2. Margin = Result (Result =Reading + Factor)–Limit
- 3. Factor= Cable Loss +Antenna Factor–Amplifier Gain

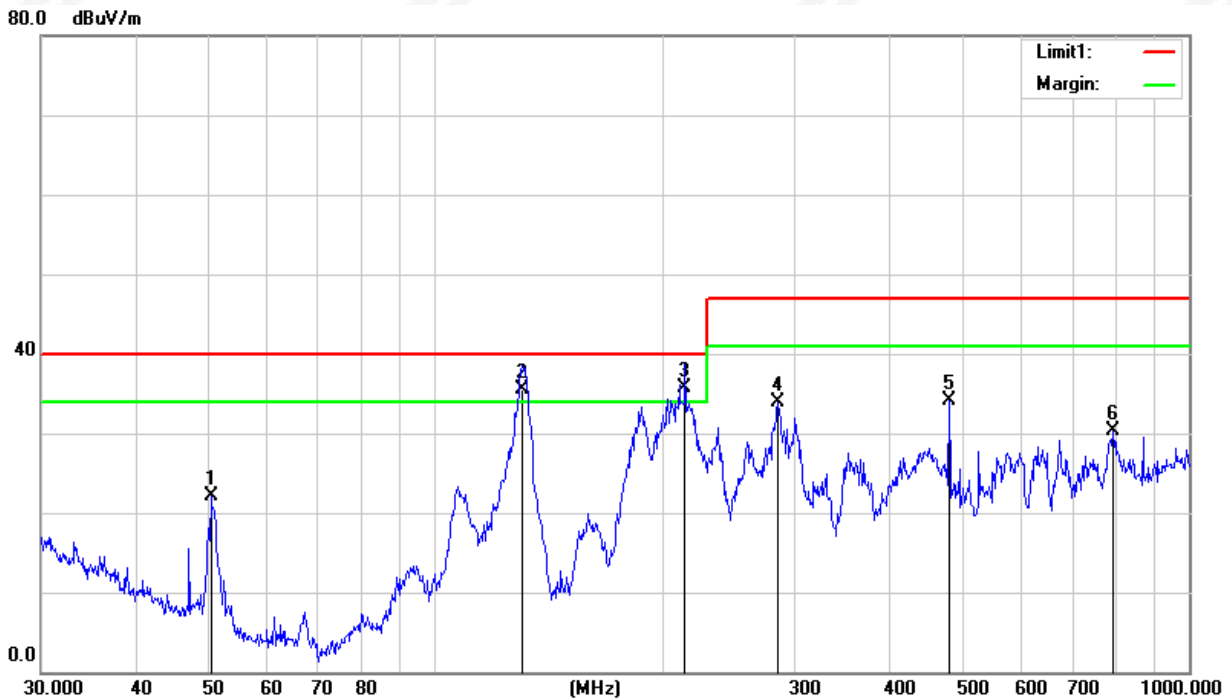

3.3 HARMONICS CURRENT

3.3.1 LIMITS OF THE HARMONICS CURRENT

EN 61000-3-2/IEC 61000-3-2					
Equipment Category	Max. Permissible Harmonic Current (in Amperes)	Equipment Category	Harmonic Order n	Max. Permissible Harmonic Current (in A) (mA/w)	
Class A	Same as Limits Specified in 4-2.1, Table - I, but only odd harmonics required	Class D	3	2.30	3.4
			5	1.14	1.9
			7	0.77	1.0
			9	0.40	0.5
			11	0.33	0.35
			13 ≤ n ≤ 39	see Table I	3.85/n
only odd harmonics required					

3.3.2 TEST PROCEDURE

- a. The EUT was placed on the top of a wooden table 0.8 meter above the ground and operated to produce the maximum harmonic components under normal operating conditions.
- b. The classification of EUT is according to section 5 of BS EN IEC 61000-3-2. The EUT is classified as follows:
 - Class A: Balanced three-phase equipment, Household appliances excluding equipment as Class D, Tools excluding portable tools, Dimmers for incandescent lamps, audio equipment, equipment not specified in one of the three other classes.
 - Class B: Portable tools. Portable tools; Arc welding equipment which is not professional equipment.
 - Class C: Lighting equipment.
 - Class D: Equipment having a specified power less than or equal to 600W of the following types: Personal computers and personal computer monitors and television receivers.
- c. The correspondent test program of test instrument to measure the current harmonics emanated from EUT is chosen. The measure time shall be not less than the time necessary for the EUT to be exercised.

3.3.3 EUT OPERATING CONDITIONS

The EUT tested system was configured as the statements of 2.3 described unless otherwise a special operating condition is specified in the following during the testing.

3.3.4 TEST SETUP

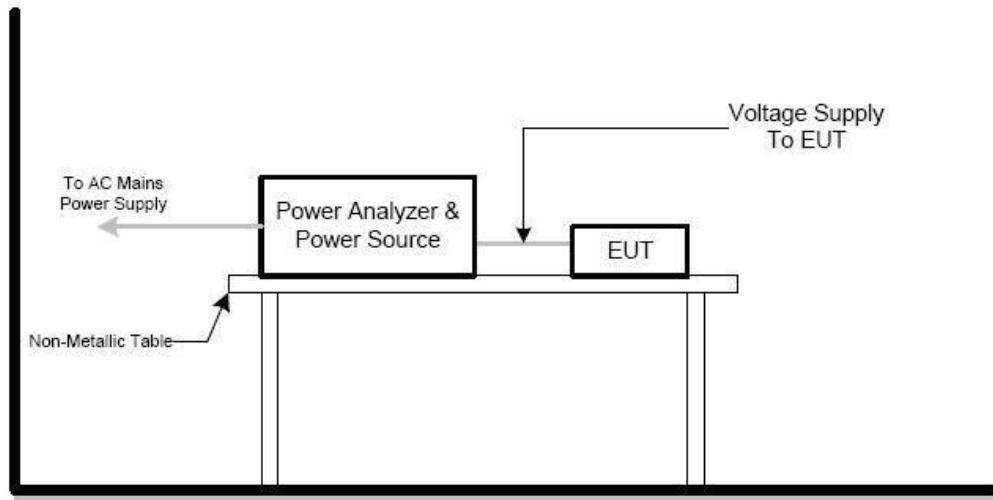

3.3.5 TEST RESULTS

Temperature:	26°C	Relative Humidity:	45%
Test Voltage:	N/A	Test Date:	N/A

Note: The above limits for all equipment except for lighting equipment having an active input power >75 W and no limits apply for equipment with an active input power up to and including 75W..

3.4 VOLTAGE FLUCTUATION AND FLICKERS

3.4.1 LIMITS OF THE VOLTAGE FLUCTUATION AND FLICKERS

Tests	Limit	Descriptions
	BS EN 61000-3-3	
P _{st}	≤ 1.0, T _p = 10 min.	Short Term Flicker Indicator
P _{lt}	≤0.65, T _p =2 hr.	Long Term Flicker Indicator
T _{dt(s)}	≤ 3.3%	Relative Steady-State V-Chang
d _{max} (%)	≤ 4%	Maximum Relative V-Chang
d _c (%)	≤ 3.3% for > 500ms	Relative V-change Characteristic

3.4.2 TEST PROCEDURE

a. Fluctuation and Flickers Test:

Tests was performed according to the Test Conditions/Assessment of Voltage Fluctuations specified in Clause 6.0/4.0 of BS EN 61000-3-3 depend.

b. All types of voltage fluctuation in this report are assessed by direct measurement using flicker-meter.

3.4.3 EUT OPERATING CONDITIONS

The EUT tested system was configured as the statements of 2.3 described unless otherwise a special operating condition is specified in the following during the testing.

3.4.4 TEST SETUP

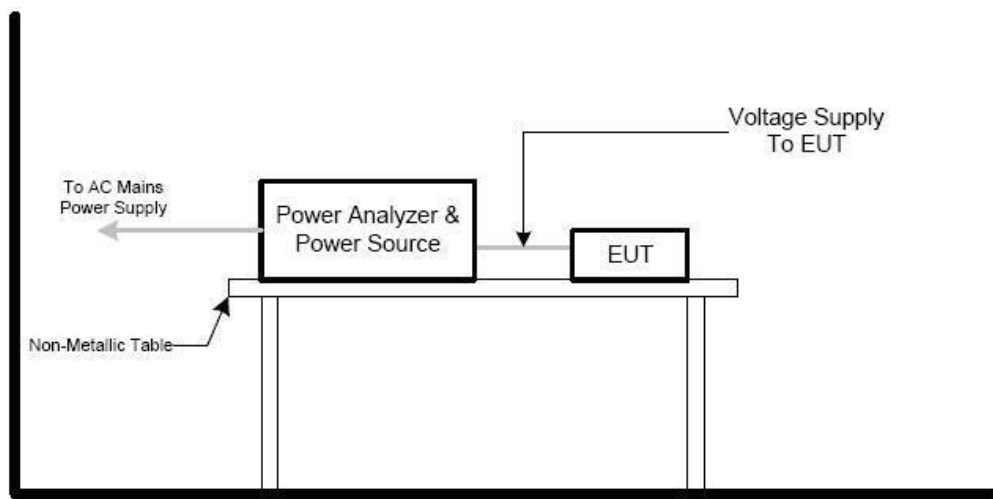



3.4.5 TEST RESULTS

EUT: Suparo Type C to Type C cable-PD100W

Operator: STAR

Test category: IEC 61000-3-3 Ed3.1:2017

Model/Type:S1001B

Measurement standard: IEC 61000-15 Ed2.0:2010

Serial number:

Test date:2024-03-27 Start time: 19:51:54

End time: 20:01:55

Test duration (sec):600

Describe:

Load Power : 8.600 W

Power Factor:0.350

Load Current : 0.106 mArms

Crest Factor:4.792

Nominal Voltage : 230.48 Vrms

Test Result: pass

Status: Test Completed

Pst and limit line

European Limits

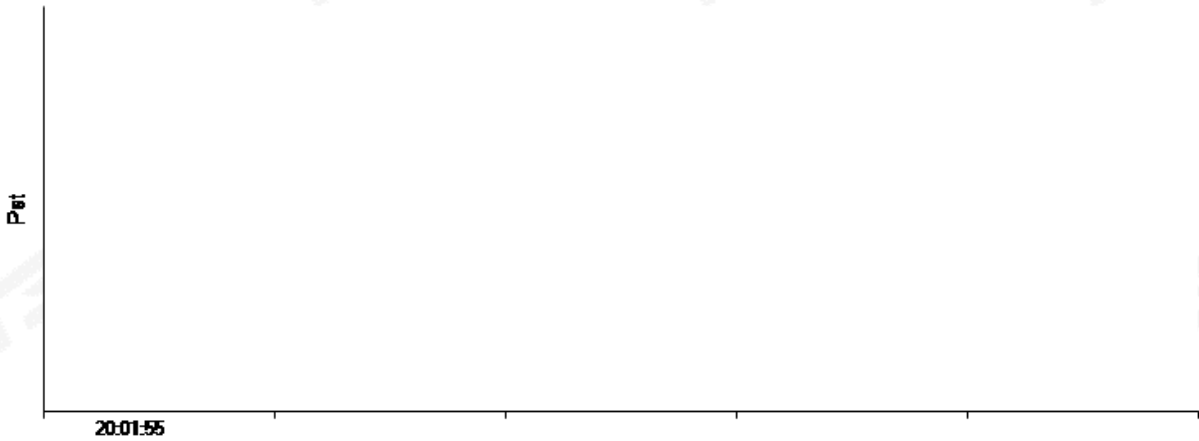

Result:

T-max (ms):	0.00	Test limit (ms):	500.00	Pass
Highest dc (%):	0.06	Test limit (%):	3.30	Pass
Highest dmax (%):	0.18	Test limit (%):	4.00	Pass
Highest Pst (10 min. period):	0.00	Test limit:	1.00	Pass

4. EMC IMMUNITY TEST

4.1 STANDARD COMPLIANCE/SERVIRITY LEVEL/CRITERIA

Tests Standard No.	TEST SPECIFICATION	Test Mode Test Ports	Perform. Criteria
1. ESD BS EN 61000-4-2	8KV air discharge 4KV contact discharge	Direct Mode	B
	4KV HCP discharge 4KV VCP discharge	Indirect Mode	B
2. RS BS EN IEC 61000-4-3	80 MHz - 1000 MHz, 1800MHz, 2600MHz, 3500MHz, 5000MHz, 1000Hz, 80%, AM modulated	Enclosure	A
3. EFT/Burst BS EN 61000-4-4	5/50ns Tr/Th 5KHz Repetition Freq.	Power Supply Port	B
	5/50ns Tr/Th 5KHz Repetition Freq.	CTL/Signal Data Line Port	B
4. Surges BS EN 61000-4-5	1.2/50(8/20) Tr/Th us	L-N	B
	1.2/50(8/20) Tr/Th us	L-PE N-PE	B
5. Injected Current BS EN 61000-4-6	0.15 MHz to 80 MHz, 1000Hz 80%, AM Modulated 150Ω source impedance	CTL/Signal Port	A
	0.15 MHz to 80 MHz, 1000Hz 80%, AM Modulated 150Ω source impedance	AC Power Port	A
	0.15 MHz to 80 MHz, 1000Hz 80%, AM Modulated 150Ω source impedance	DC Power Port	A
6. Power Frequency Magnetic Field BS EN 61000-4-8	50 Hz,	Enclosure	A
7. Volt. Interruptions Volt. Dips BS EN IEC 61000-4-11	Voltage dip 100%	AC Power Port	B
	Voltage dip 30%		C
	Interruption 100%		C

4.2 GENERAL PERFORMANCE CRITERIA

According to **BS EN 55035** standard, the general performance criteria are as follows:

Criterion A	The equipment shall continue to operate as intended without operator intervention. No degradation of performance, loss of function or change of operating state is allowed below a performance level specified by the manufacturer when the equipment is used as intended. The performance level may be replaced by a permissible loss of performance. If the minimum performance level or the permissible performance loss is not specified by the manufacturer, then either of these may be derived from the product description and documentation, and by what the user may reasonably expect from the equipment if used as intended.
Criterion B	During the application of the disturbance, degradation of performance is allowed. However, no unintended change of actual operating state or stored data is allowed to persist after the test. After the test, the equipment shall continue to operate as intended without operator intervention; no degradation of performance or loss of function is allowed, below a performance level specified by the manufacturer, when the equipment is used as intended. The performance level may be replaced by a permissible loss of performance. If the minimum performance level (or the permissible performance loss), or recovery time, is not specified by the manufacturer, then either of these may be derived from the product description and documentation, and by what the user may reasonably expect from the equipment if used as intended.
Criterion C	Loss of function is allowed, provided the function is self-recoverable, or can be restored by the operation of the controls by the user in accordance with the manufacturer's instructions. A reboot or re-start operation is allowed. Information stored in non-volatile memory, or protected by a battery backup, shall not be lost.

4.2.1 GENERAL PERFORMANCE CRITERIA TEST SETUP

The EUT tested system was configured as the statements of **2.2** or **2.3** unless otherwise a special operating condition is specified in the following during the testing.

4.3 ELECTROSTATIC DISCHARGE IMMUNITY TEST (ESD)

4.3.1 TEST SPECIFICATION

Basic Standard:	BS EN 61000-4-2
Discharge Impedance:	330 ohm / 150 pF
Required Performance:	B
Discharge Voltage:	Air Discharge : 2KV/4KV/8KV (Direct) Contact Discharge : 4KV (Direct/Indirect)
Polarity:	Positive & Negative
Number of Discharge:	Air Discharge: at least 10 times on each point Contact Discharge: at least 10 times on each point 20 times at each test point
Discharge Mode:	Single Discharge
Discharge Period:	1 second minimum

4.3.2 TEST PROCEDURE

The test generator necessary to perform direct and indirect application of discharges to the EUT in the following manners:

- a. Electrostatic discharges were applied only to those points and surfaces of the EUT that are accessible to users during normal operation
The test was performed with at least ten single discharges on the pre-selected points in the most sensitive polarity.

The time interval between two successive single discharges was at least 1 second.

The ESD generator was held perpendicularly to the surface to which the discharge was applied and the return cable was at least 0.2 meter from the EUT.

Contact discharges were applied to the non-insulating coating, with the pointed tip of the generator penetrating the coating and contacting the conducting substrate.

Air discharges were applied with the round discharge tip of the discharge electrode approaching the EUT as fast as possible (without causing mechanical damage) to touch the EUT. After each discharge, the ESD generator was removed from the EUT and re-triggered for a new single discharge. The test was repeated until all discharges were complete.

Vertical Coupling Plane (VCP):

The coupling plane of dimensions 0.5m x 0.5m, is placed parallel to and positioned at a distance 0.1m from the EUT, with the Discharge Electrode touching the coupling plane.

The four faces of the EUT will be performed with electrostatic discharge.

Horizontal Coupling Plane (HCP):

The coupling plane is placed under to the EUT. The generator shall be positioned vertically at a distance of 0.1m from the EUT, with the Discharge Electrode touching the coupling plane.

The four faces of the EUT will be performed with electrostatic discharge.

- b. Air discharges at insulation surfaces of the EUT.
It was at least ten single discharges with positive and negative at the same selected point.

4.3.3 TEST SETUP

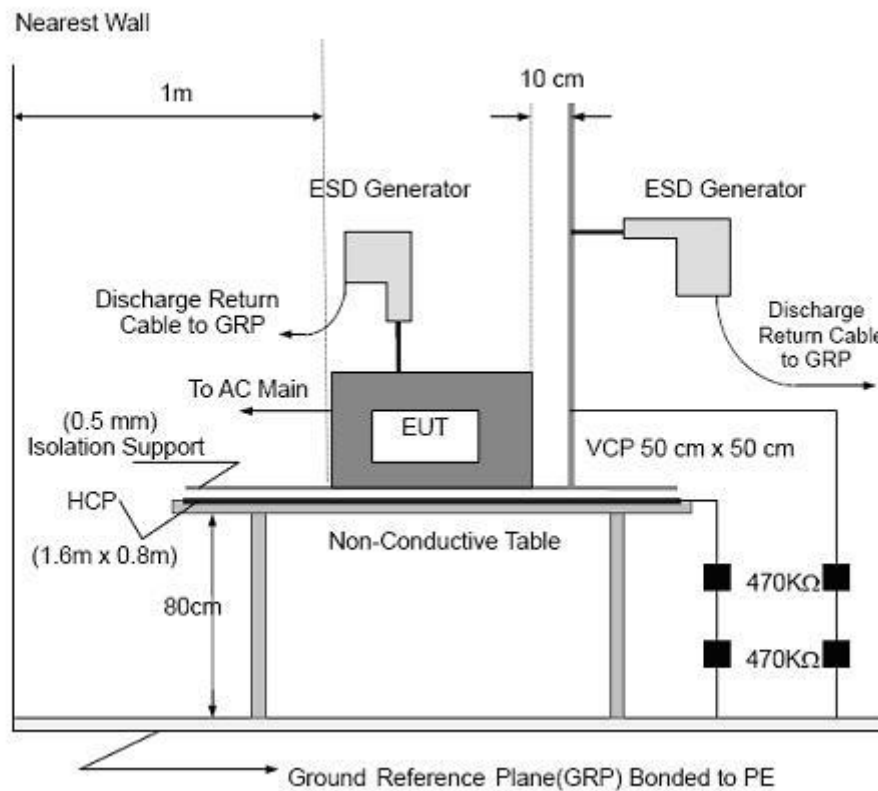

Note:

TABLE-TOP EQUIPMENT

The configuration consisted of a wooden table 0.8 meter high standing on the Ground Reference Plane. The GRP consisted of a sheet of aluminum at least 0.25mm thick. A Horizontal Coupling Plane (1.6m x 0.8m) was placed on the table and attached to the GRP by means of a cable with 940kΩ total impedance. The equipment under test was installed in a representative system as described in section 7 of BS EN 61000-4-2, and its cables were placed on the HCP and isolated by an insulating support of 0.5mm thickness. A distance of 0.8-meter minimum was provided between the EUT and the walls of the laboratory and any other metallic structure.

FLOOR-STANDING EQUIPMENT

The equipment under test was installed in a representative system as described in section 7 of BS EN 61000-4-2, and its cables were isolated from the Ground Reference Plane by an insulating support of 0.1 meter thickness. The GRP was consisted of a sheet of aluminum that is at least 0.25mm thick, and extended at least 0.5 meter from the EUT on all sides.



4.3.4 TEST RESULTS

Temperature:	25.3°C	Relative Humidity:	47%
Pressure:	1017.8hPa	Test Voltage:	AC 230V/50Hz
Test Mode:	Mode 1/2	Test Date:	2024.03.28

Discharge Level	Polarity	Test Points	Contact Discharge	Air Discharge	Criterion	Test Result
2,4	+/-	VCP/HCP	NOTE	N/A	B	A
2,4,8	+/-	Red Dot	N/A	NOTE	B	A

Note: The EUT function was correct during the test
Red Dot —Air Discharged
Green Dot —Contact Discharged

The Photo for Discharge Points of EUT



4.4 RADIATED, RADIO-FREQUENCY, ELECTROMAGNETIC FIELD IMMUNITY TEST (RS)

4.4.1 TEST SPECIFICATION

Basic Standard:	BS EN IEC 61000-4-3
Required Performance:	A
Test Frequency Range:	80 MHz-1000 MHz, 1800MHz, 2600MHz, 3500MHz, 5000MHz
Primary Function Of Telephony Test Frequencies:	80 MHz; 120 MHz; 160 MHz; 230 MHz; 434 MHz; 460 MHz; 600 MHz; 863 MHz and 900 MHz
Field Strength:	3 V/m
Modulation:	1kHz Sine Wave, 80%, AM Modulation
Frequency Step:	1 % of fundamental
Polarity of Antenna:	Horizontal and Vertical
Test Distance:	3 m
Antenna Height:	1.5 m
Dwell Time:	3s

4.4.2 TEST PROCEDURE

- a. The testing was performed in a fully anechoic chamber. The transmit antenna was located at a distance of 3 meters from the EUT.
- b. The frequency range is swept from 80 MHz to 1000 MHz, 1800MHz, 2600MHz, 3500MHz, 5000MHz, with the signal 80% amplitude modulated with a 1kHz sine-wave. The rate of sweep did not exceed 3s, where the frequency range is swept incrementally, the step size was 1% of preceding frequency value.
- c. The dwell time at each frequency shall be not less than the time necessary for the EUT to be able to respond.
- e. The test was performed with the EUT exposed to both vertically and horizontally polarized fields on each of the four sides.

4.4.3 TEST SETUP

(A) RS Test Set-Up Frequency Below 1GHz

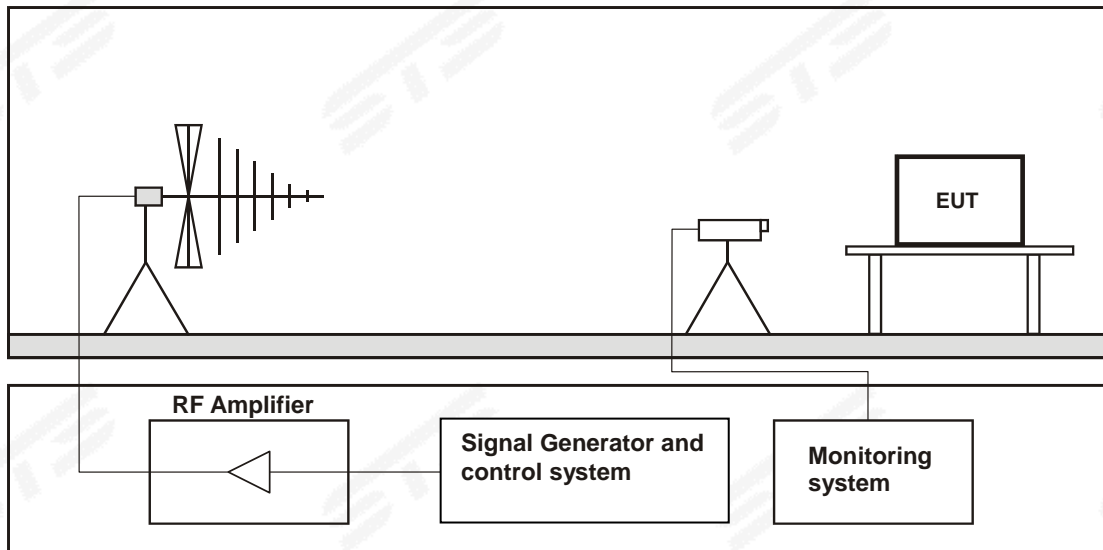

(B) RS Test Set-Up Frequency Above 1GHz

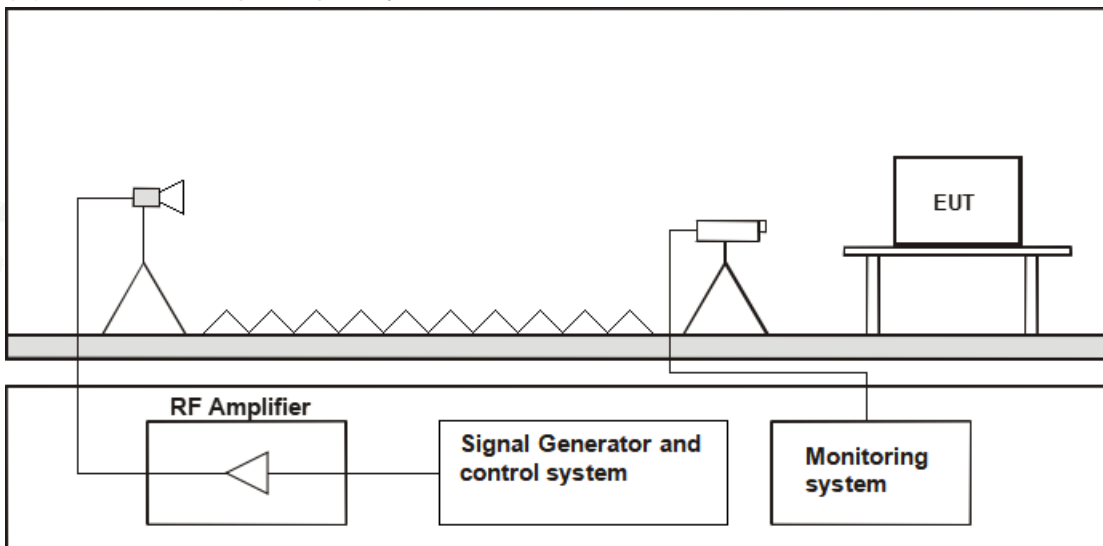

Note:

TABLE-TOP EQUIPMENT

The EUT installed in a representative system as described in section 7 of BS EN IEC 61000-4-3 was placed on a non-conductive table 0.8 meter in height. The system under test was connected to the power and signal wire according to the relevant installation instructions.

FLOOR-STANDING EQUIPMENT

The EUT installed in a representative system as described in section 7 of BS EN IEC 61000-4-3 was placed on a non-conductive wood support 0.1 meter in height. The system under test was connected to the power and signal wire according to the relevant installation instructions.

**4.4.4 TEST RESULTS**

Temperature:	25.3°C	Relative Humidity:	47%
Test Voltage:	AC 230V/50Hz	Test Date:	2024.03.28
Test Mode:	Mode 1/2		

Frequency Range (MHz)	RF Field Position	R.F. Field Strength	Azimuth	Perform. Criteria	Results	Judgement
80MHz - 1000MHz	H / V	3 V/m (rms) AM Modulated 1000Hz, 80%	Front	A	A	PASS
			Rear			
			Left			
			Right			
1800MHz	H / V	3 V/m (rms) AM Modulated 1000Hz, 80%	Front	A	A	PASS
			Rear			
			Left			
			Right			
2600MHz	H / V	3 V/m (rms) AM Modulated 1000Hz, 80%	Front	A	A	PASS
			Rear			
			Left			
			Right			
3500MHz	H / V	3 V/m (rms) AM Modulated 1000Hz, 80%	Front	A	A	PASS
			Rear			
			Left			
			Right			
5000MHz	H / V	3 V/m (rms) AM Modulated 1000Hz, 80%	Front	A	A	PASS
			Rear			
			Left			
			Right			

4.5 ELECTRICAL FAST TRANSIENT (EFT)

4.5.1 TEST SPECIFICATION

Basic Standard:	BS EN 61000-4-4
Required Performance:	B
Test Voltage:	Power Line: 1 KV Signal/Control Line: 0.5 KV DC network power port: 0.5 KV
Polarity:	Positive & Negative
Impulse Frequency:	5 kHz
Impulse Wave shape :	5/50 ns
Burst Duration:	15ms
Burst Period:	300ms
Test Duration:	Not less than 1 min

4.5.2 TEST PROCEDURE

The ground reference plane shall be a metallic sheet (copper or aluminum) of 0.25 mm minimum thickness; other metallic materials may be used, but they shall have at least 0.65 mm minimum thickness.

The other conditions required in the following manners:

- a. The length of power cord between the coupling device and the EUT should not exceed 1 meter.
- b. Both positive and negative polarity discharges were applied.
- c. The duration time of each test sequential was 1 minutes.

4.5.3 TEST SETUP

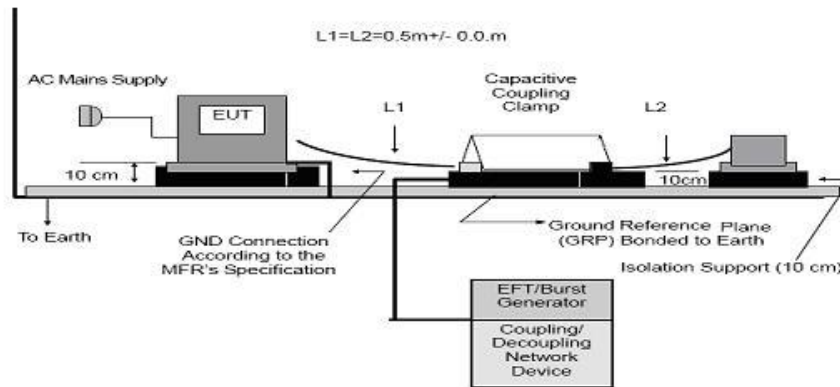
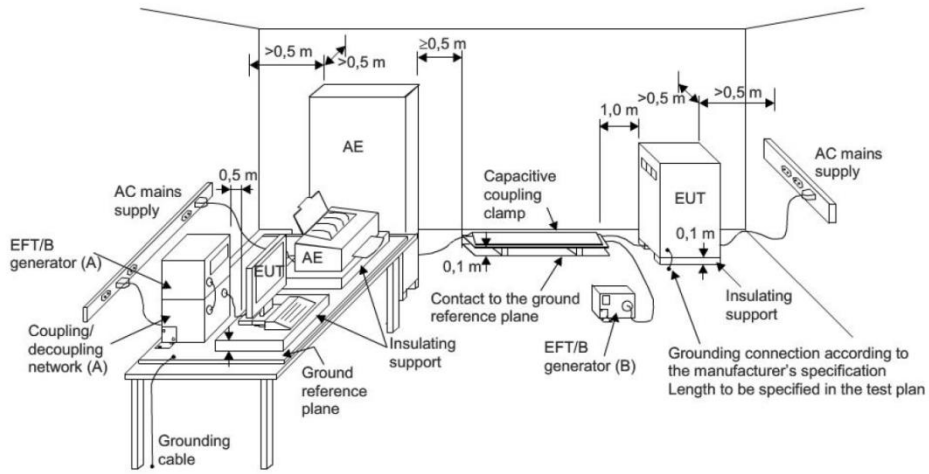

Note:

TABLE-TOP EQUIPMENT

- a. Table-top equipment and equipment normally mounted on ceilings or walls as well as built-in equipment shall be tested with the EUT located (0.1 ± 0.01) m above the ground reference plane.
- b. Testing of large table-top equipment or multiple systems can be performed on the floor; maintaining the same distances as for the test setup of table-top equipment.
- c. The test generator and the coupling/decoupling network shall be bonded to the ground reference plane.
- d. The ground reference plane shall be a metallic sheet (copper or aluminum) of 0.25mm minimum thickness; other metallic materials may be used, but they shall have at least 0.65 mm minimum thickness.
- e. The minimum size of the ground reference plane is 0.8m x 1m. The actual size depends on the dimension of the EUT.
- f. The ground reference plane shall project beyond the EUT by at least 0.1m on all sides.
- g. The ground reference plane shall be connected to the earth (PE) for safety reasons.
- h. The EUT shall be arranged and connected to satisfy its functional requirements according to the equipment installation specifications.
- i. The minimum distance between the EUT and all other conductive structures (including the generator, AE and the walls of a shielded room), except the ground reference plane, shall be more than 0.5m.
- j. All cables to the EUT shall be placed on the insulation support 0.1m above the ground reference plane. Cables not subject to electrical fast transients shall be routed as far as possible from the cable under test to minimize the coupling between the cables.
- k. The EUT shall be connected to the earth system in accordance with the manufacturer's installation specifications; no additional earth connections are allowed.
- l. The connection impedance of the coupling/decoupling network earth cables to the ground reference plane and all connectors shall provide a low inductance.
- m. Either a direct coupling network or a capacitive clamp shall be used for the application of the test voltages. The test voltages shall be coupled to all of the EUT ports in turn including those between two units of equipment involved in the test, unless the length of the interconnecting cable makes it impossible to test.

FLOOR-STANDING EQUIPMENT

When using the coupling clamp, the minimum distance between the coupling plates and all other conductive surfaces (including the generator), except the ground reference plane beneath the coupling clamp and beneath the EUT, shall be at least 0.5m.

The distance between any coupling devices and the EUT shall be ($0.5 - 0/+0.1$) m for tabletop equipment testing, and (1.0 ± 0.1) m for floor standing equipment, unless otherwise specified in product standards. When it is not physically possible to apply the distances mentioned above, other distances can be used and shall be recorded in the test report.

The cable between the EUT and the coupling device, if detachable, shall be as short as possible to comply with the requirements of this clause. If the manufacturer provides a cable exceeding the distance between the coupling device and the point of entry of the EUT, the excess length of this cable shall be bundled and situated at a distance of 0.1m above the ground reference plane. When a capacitive clamp is used as a coupling device, the excess cable length shall be bundled at the AE side.

Parts of the EUT with interconnecting cables of a length less than 3m, which are not tested, shall be placed on the insulating support. The parts of the EUT shall have a distance of 0.5m between them. Excess cable length shall be bundled.



4.5.4 TEST RESULTS

Temperature:	25.3°C	Relative Humidity:	47%
Test Voltage:	AC 230V/50Hz	Test Date:	2024.03.28
Test Mode:	Mode 1/2		

Coupling Line		Test level	Perform. Criteria	Results	Judgement
AC line	L	±1KV	B	A	PASS
	N	±1KV		A	PASS
	PE	N/A		N/A	N/A
	L+N	±1KV		A	PASS
	L+PE	N/A		N/A	N/A
	N+PE	N/A		N/A	N/A
	L+N+PE	N/A		N/A	N/A
DC network power port Line		N/A		N/A	N/A
Signal Line		N/A		N/A	N/A

Note: 1) N/A - denotes test is not applicable in this test report.

4.6 SURGE TESTING

4.6.1 TEST SPECIFICATION

Basic Standard:	BS EN 61000-4-5
Required Performance:	B
Wave-Shape:	Combination Wave 1.2/50us Open Circuit Voltage
Test Voltage:	Power line ~ line to line: 1 KV line to ground: 2 KV Telecommunication line: 0.5 KV DC network power port: 0.5 KV
Surge Input/Output:	L-N, L-PE, N-PE
Generator Source:	(L-N)2 ohm between networks
Impedance:	(L-PE, N-PE)12 ohm between network and ground
Polarity:	Positive/Negative
Phase Angle:	0°/90°/180°/270°
Pulse Repetition Rate:	1 time / min. (maximum)
Number of Tests:	5 positive and 5 negative at selected points

4.6.2 TEST PROCEDURE

- a. For EUT power supply:
The surge is to be applied to the EUT power supply terminals via the capacitive coupling network. Decoupling networks are required in order to avoid possible adverse effects on equipment not under test that may be powered by the same lines, and to provide sufficient decoupling impedance to the surge wave. The power cord between the EUT and the coupling/decoupling networks shall be 2meter in length (or shorter).
- b. For test applied to unshielded unsymmetrical operated interconnection lines of EUT:
The surge is applied to the lines via the capacitive coupling. The coupling /decoupling networks shall not influence the specified functional conditions of the EUT. The interconnection line between the EUT and the coupling/decoupling networks shall be 2 meter in length (or shorter).

4.6.3 TEST SETUP

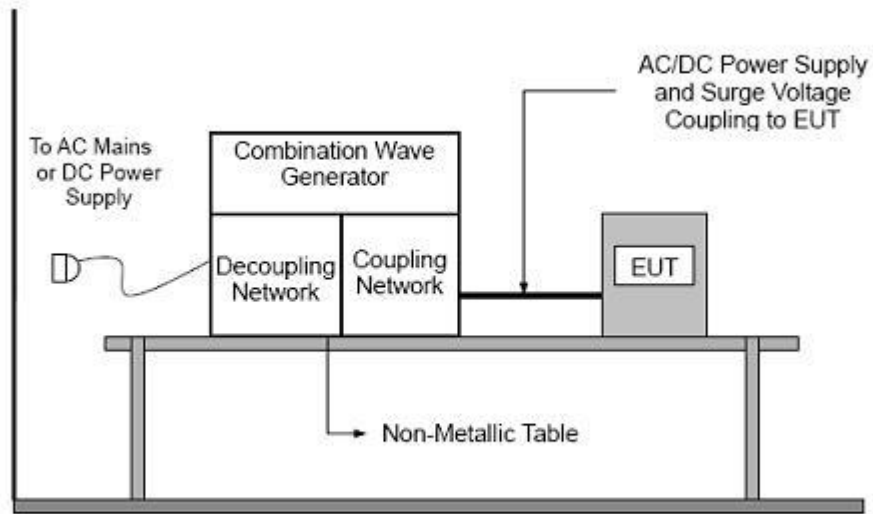



4.6.4 TEST RESULTS

Temperature:	25.3°C	Relative Humidity:	47%
Test Voltage:	AC 230V/50Hz	Test Date:	2024.03.28
Test Mode:	Mode 1/2		

Coupling Line			Test level								Criterion	Result
			0.5 KV		1 KV		2 KV		4 KV			
			+	-	+	-	+	-	+	-		
AC line	L-N	0°			A	A					B	PASS
		90°			A	A						
		180°			A	A						
		270°			A	A						
	L-PE	0°										
		90°										
		180°										
		270°										
	N-PE	0°										
		90°										
		180°										
		270°										
Signal Line	Line-Line											
	Line-Ground											
DC Line												

Note: 1) N/A - denotes test is not applicable in this test report.

4.7 CONDUCTED RADIO FREQUENCY DISTURBANCES (CS)

4.7.1 TEST SPECIFICATION

Basic Standard:	BS EN 61000-4-6
Required Performance:	A
Test Frequency Range:	0.15 MHz-80 MHz
Primary Function Of Telephony Test Frequencies:	0.2 MHz; 1 MHz; 7.1 MHz; 13.56 MHz; 21 MHz; 27.12 MHz and 40.68 MHz
Field Strength:	0.15 MHz - 10 MHz, 3V 10 MHz - 30 MHz, 3V to 1V 30 MHz - 80 MHz, 1V
Modulation:	1kHz Sine Wave, 80%, AM Modulation
Frequency Step:	1 % of fundamental
Dwell Time:	3s

4.7.2 TEST PROCEDURE

The EUT shall be tested within its intended operating and climatic conditions.

The test shall be performed with the test generator connected to each of the coupling and decoupling devices in turn, while the other non-excited RF input ports of the coupling devices are terminated by a 50-ohm load resistor.

The frequency range was swept from 150 kHz to 10 MHz, 10 MHz to 30 MHz, 30 MHz to 80 MHz using the signal level established during the setting process and with a disturbance signal of 80 % amplitude. The signal was modulated with a 1 kHz sine wave, pausing to adjust the RF signal level or the switch coupling devices as necessary. The sweep rate was 3s. Where the frequency range is swept incrementally, the step size was 1 % of preceding frequency value from 150 kHz to 80MHz.

The dwell time at each frequency was less than the time necessary for the EUT to be exercised, and able to respond. Sensitive frequencies such as clock frequency (ies) and harmonics or frequencies of dominant interest, was analyzed separately.

Attempts were made to fully exercise the EUT during testing, and to fully interrogate all exercise modes selected for susceptibility.

4.7.3 TEST SETUP

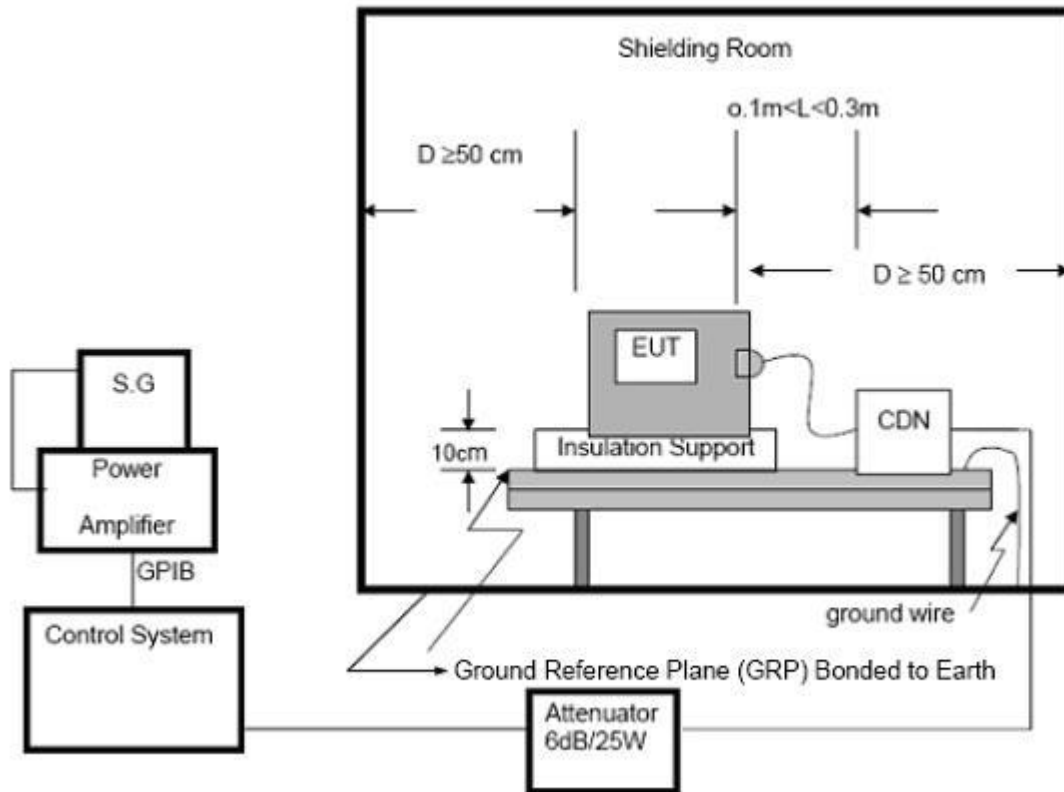

NOTE:

FLOOR-STANDING EQUIPMENT

The equipment to be tested is placed on an insulating support of 0.1 meter height above a ground reference plane. All relevant cables shall be provided with the appropriate coupling and decoupling devices at a distance between 0.1 meter and 0.3 meter from the projected geometry of the EUT on the ground reference plane.

**4.7.4 TEST RESULTS**

Temperature:	25.3°C	Relative Humidity:	47%
Test Voltage:	AC 230V/50Hz	Test Date:	2024.03.28
Test Mode:	Mode 1/2		

Test Ports (Mode)	Freq. Range (MHz)	Field Strength	Perform. Criteria	Results	Judgement
Input/ Output AC. Power Port	0.15 - 10	3V(rms) AM Modulated 1000Hz, 80%	A	A	PASS
	10 - 30	3V to 1V(rms) AM Modulated 1000Hz, 80%			
	30 - 80	1V(rms) AM Modulated 1000Hz, 80%			
Input/ Output DC. Power Port	0.15 - 10	3V(rms) AM Modulated 1000Hz, 80%	N/A	N/A	N/A
	10 - 30	3V to 1V(rms) AM Modulated 1000Hz, 80%			
	30 - 80	1V(rms) AM Modulated 1000Hz, 80%			
Signal Line	0.15 - 10	3V(rms) AM Modulated 1000Hz, 80%	N/A	N/A	N/A
	10 - 30	3V to 1V(rms) AM Modulated 1000Hz, 80%			
	30 - 80	1V(rms) AM Modulated 1000Hz, 80%			

Note: 1) N/A - denotes test is not applicable in this test report.

4.8 VOLTAGE INTERRUPTION/DIPS TESTING (DIPS)

4.8.1 TEST SPECIFICATION

Basic Standard:	BS EN IEC 61000-4-11
Required Performance:	B (For 100% Voltage Dips, 0.5 Cycle) C (For 30% Voltage Dips, 25 Cycles) C (For 100% Voltage Interruptions, 250 Cycles)
Test Duration Time:	Minimum 3 test events in sequence
Interval between Event:	Minimum 10 seconds
Phase Angle:	0°/45°/90°/135°/180°/225°/270°/315°/360°
Test Cycle:	3 times

4.8.2 TEST PROCEDURE

The EUT shall be tested for each selected combination of test levels and duration with a sequence of three dips/interruptions with intervals of 10 s minimum (between each test event). Each representative mode of operation shall be tested. Abrupt changes in supply voltage shall occur at zero crossings of the voltage waveform.

4.8.3 TEST SETUP

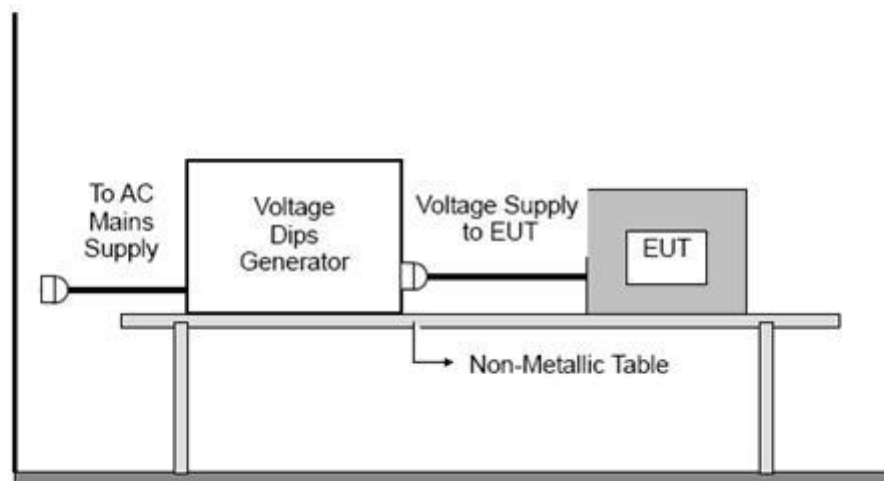

**4.8.4 TEST RESULTS**

Temperature:	25.3°C	Relative Humidity:	47%
Test Voltage:	AC 230V/50Hz	Test Date:	2024.03.28
Test Mode:	Mode 1/2		

Interruption & Dips	Duration (T)	Perform Criteria	Results	Judgement
Interruption 0%	0.5	B	A	PASS
Voltage dip 70%	25	C	A	PASS
Interruption 0%	250	C	A	PASS

APPENDIX 1 - TEST SETUP

RE (30 - 1000 MHz)

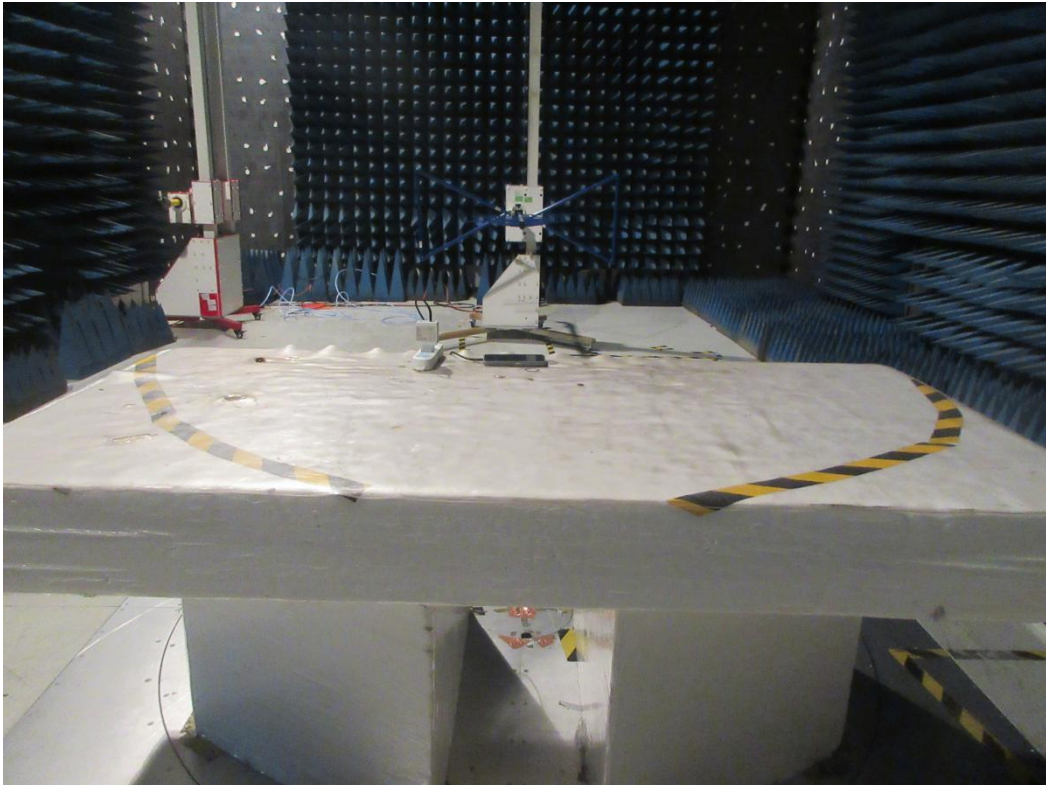

CE



FLICKER



SURGE

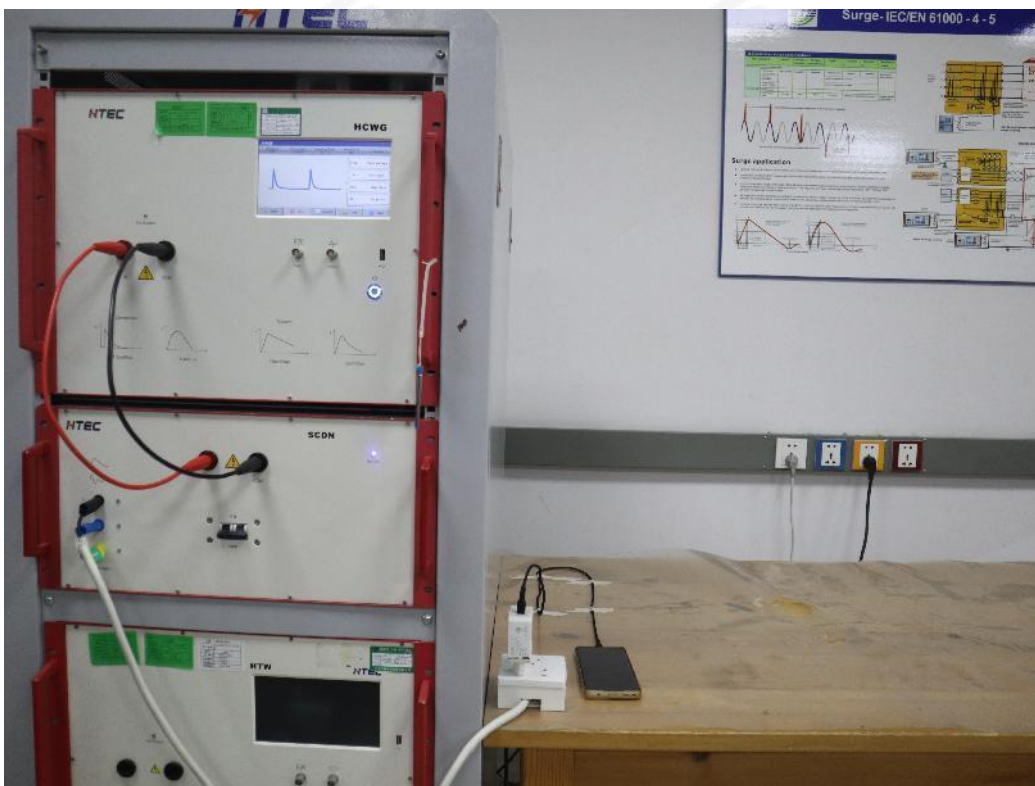

EFT

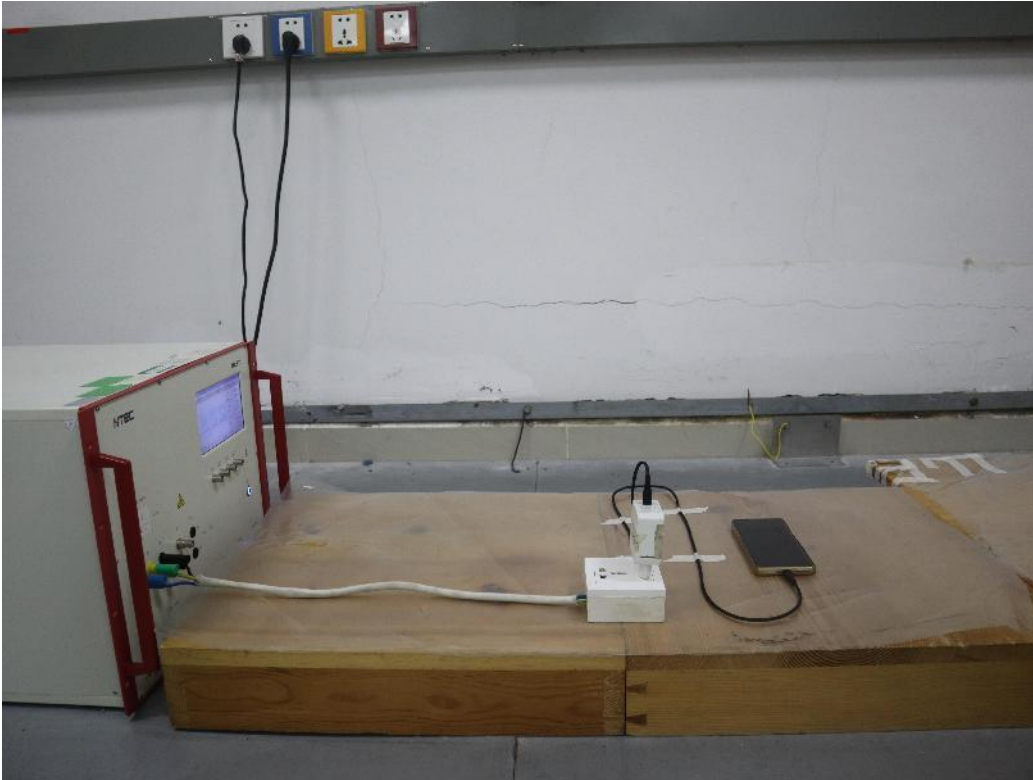

DIPS

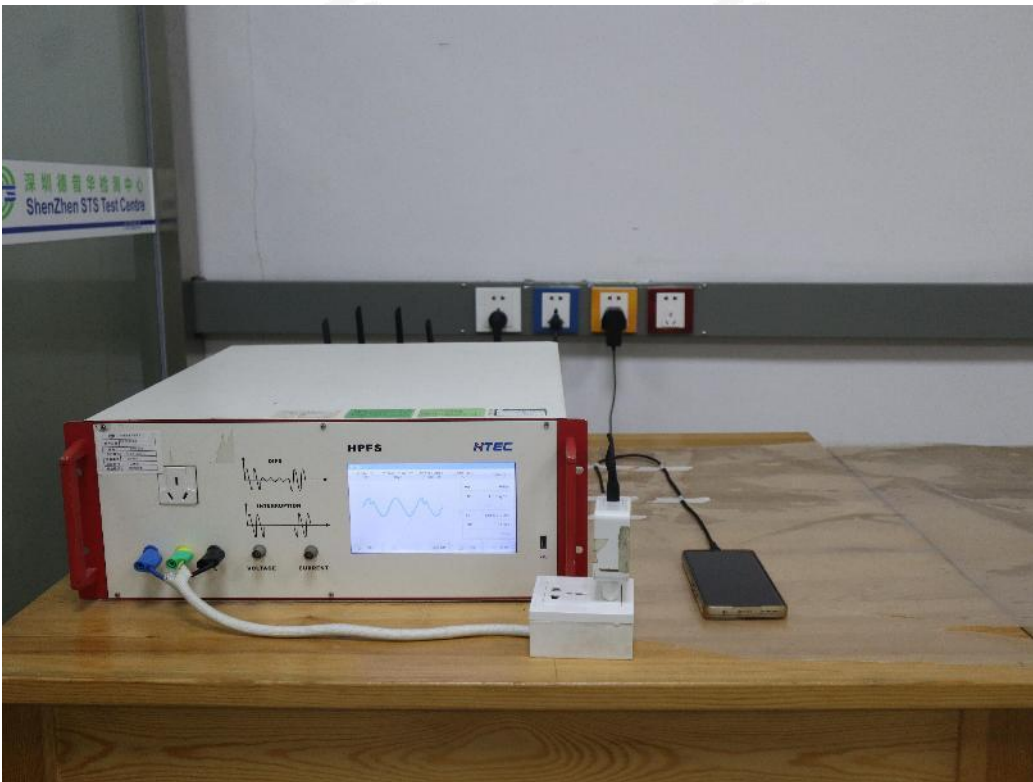

ESD



CS

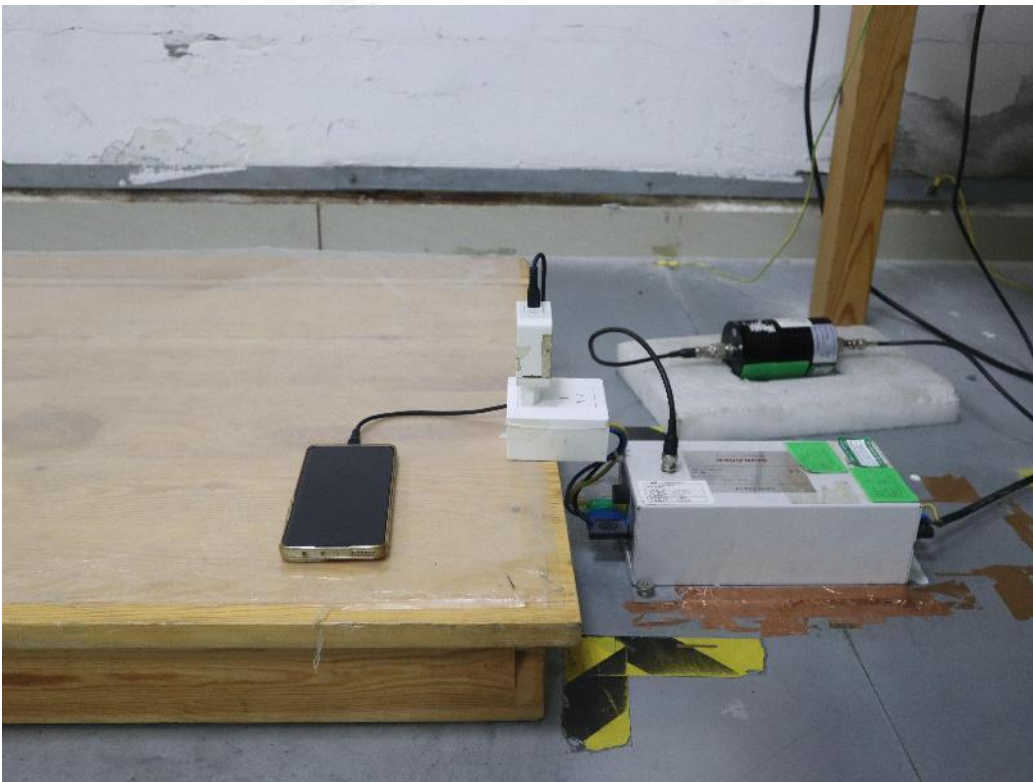

RS (80 - 1000 MHz)

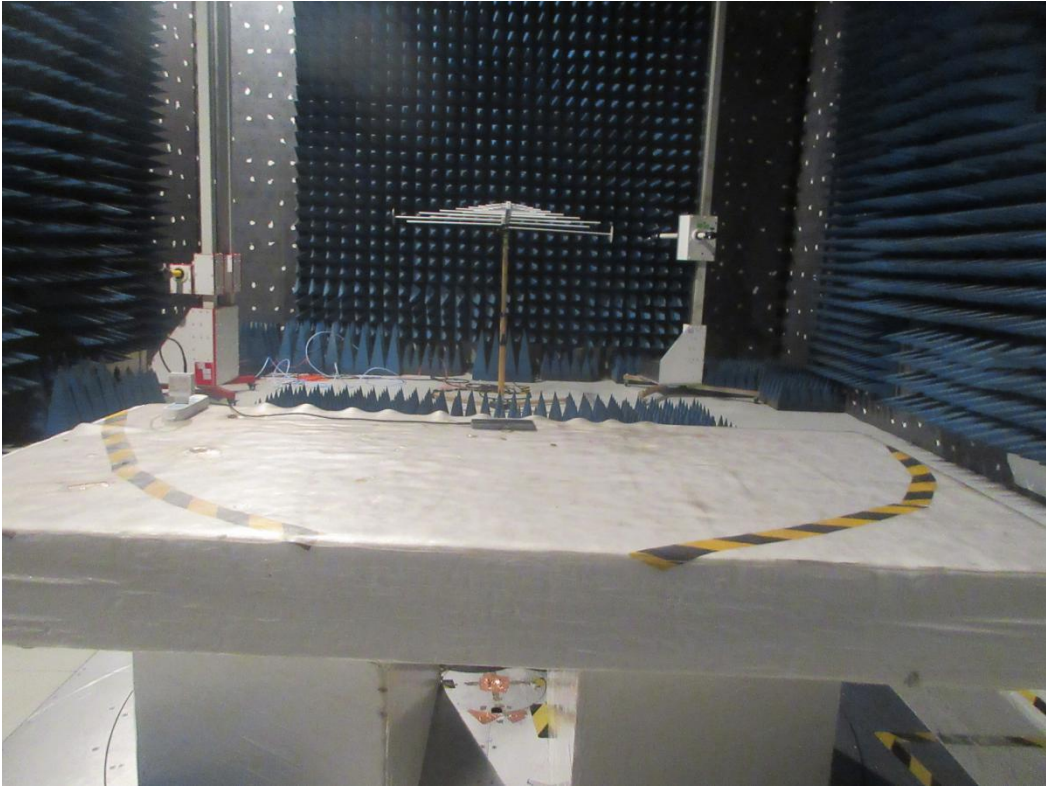

RS (1000 - 5000 MHz)

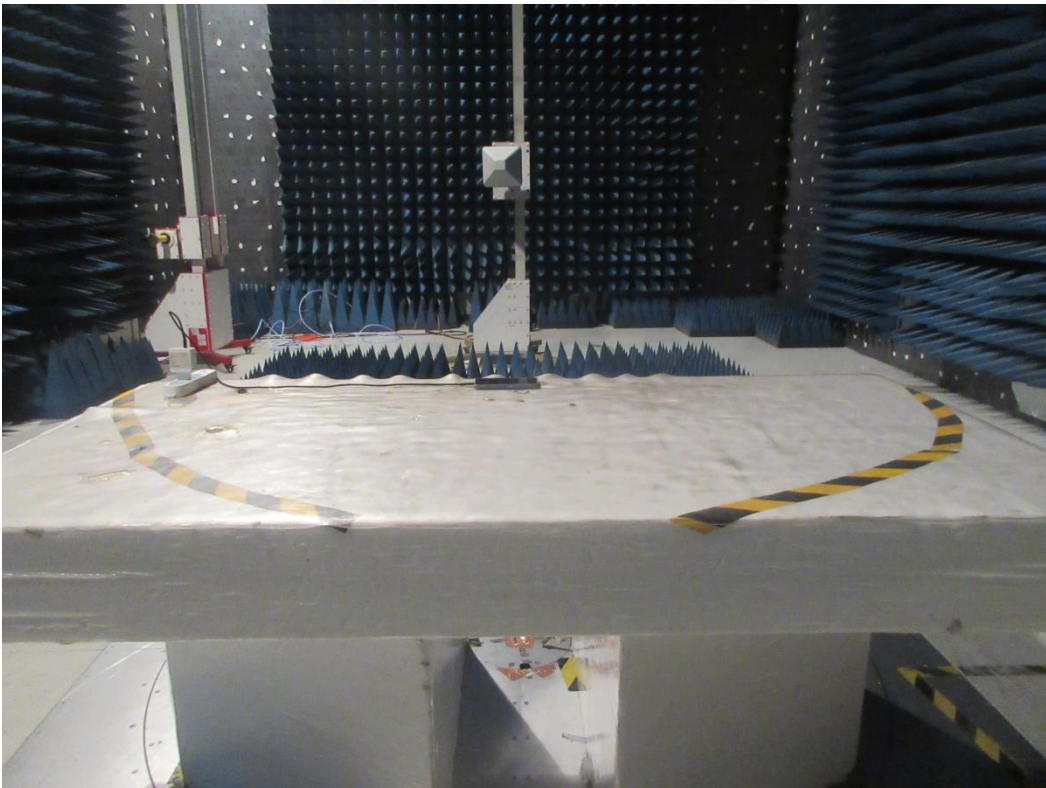

APPENDIX 2 - PHOTOGRAPHS OF EUT CONSTRUCTIONAL DETAILS

Photo 1

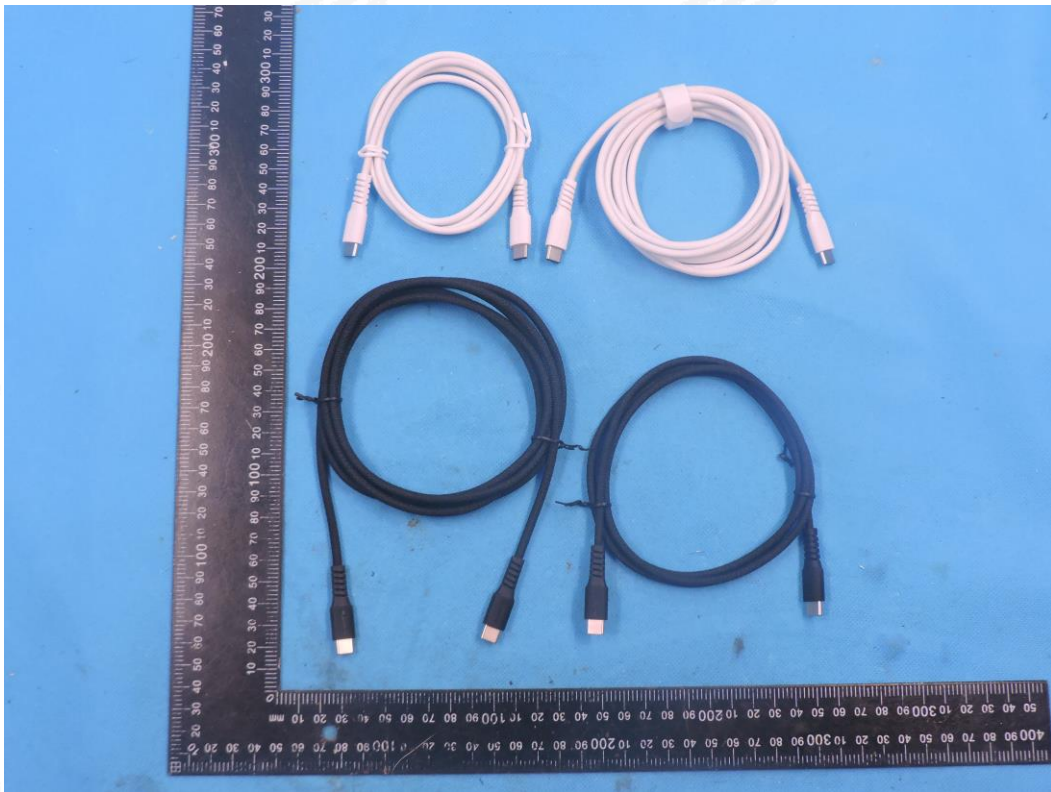

Photo 2



Photo 3



Photo 4



Photo 5



Photo 6



*****END OF THE REPORT*****